

Rolled Form Screen Frames & Parts

- | | |
|--------------------------|--------------------------|
| #087-02ALMD Almond | #087-024ALMD Almond |
| #087-02BRZ Bronze | #087-024BRZ Bronze |
| #087-02MILL Mill | #087-024MILL Mill |
| #087-02WHT White | #087-024WHT White |
| .019 Gauge 12' 6" Length | .024 Gauge 12' 6" Length |



#087-20
.140 Spline



#087-305
Loop Latch
Double Hung
Hardware

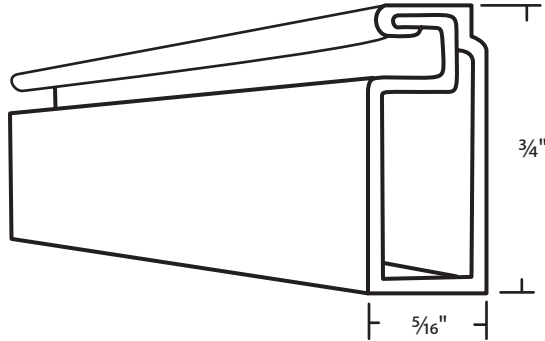
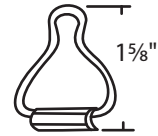

Choose one of the following Springs:

#087-306
Hairpin Clip

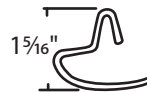

#087-307
Corner L Spring



#087-308
Leaf Spring

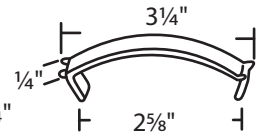

Choose one of the following Fastening Systems:

#087-156BLK Black
#087-156WHT White
5/32" Plunger Assembly



#087-157BLK Black
#087-157WHT White
5/32" Plunger Assembly
Flip Type



#087-158BLK Black
#087-158WHT White
7/32" Plunger Assembly



#087-159BLK Black
#087-159WHT White
7/32" Plunger Assembly
Flip Type



#087-154 5/32" Dia.
Fixed Pin

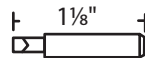

#087-155 7/32" Dia.
Fixed Pin

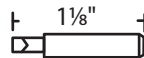

#087-304 Aluminum
Butterfly Latch

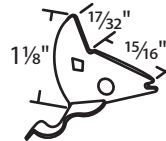

#087-311
Pointer Latch



Choose one of the following Corner Keys:

#087-200 White
Inside Plastic Miter



#087-201ALMD Almond
#087-201BRZ Bronze
#087-201MILL Mill
#087-201WHT White
Outside Plastic
Straight Cut

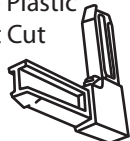

#087-202ALMD Almond
#087-202BRZ Bronze
#087-202MILL Mill
#087-202WHT White
Outside Plastic w/ Notch

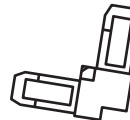

#087-203ALMD Almond
#087-203BRZ Bronze
#087-203MILL Mill
#087-203WHT White
Outside Plastic w/ Offset

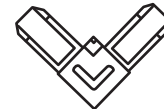

Choose one of the following Pull Tabs:

#087-150BLK Black
#087-150C Clear
#087-150WHT White
Vinyl Pull Tab

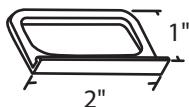

#087-151BLK Black Flexible
#087-153BLK Black Rigid
Vinyl Pull Tab



#087-152MILL Mill
#087-150WHT White
Aluminum Pull Tab

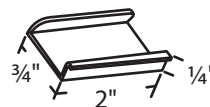

#087-160BLK Black
#087-160C Clear
#087-160WHT White
Vinyl Pull Tab

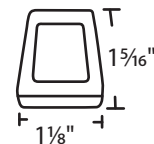

Rolled Form Screen Frames & Parts

#087-03BRZ Bronze
 #087-03MILL Mill
 #087-03WHT White
 Lift Rail .019 Gauge



#087-20
 .140 Spline

#087-305
 Loop Latch
 Double Hung
 Hardware

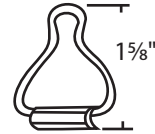
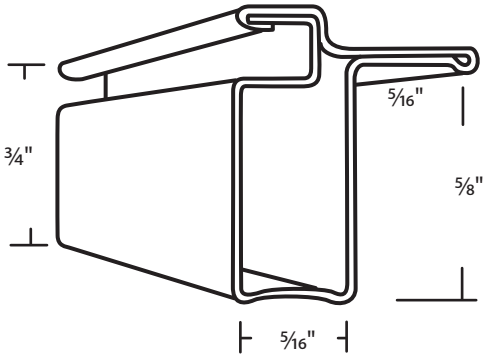

Choose one of the following Springs:

#087-306
 Hairpin Clip

#087-307
 Corner L Spring

#087-308
 Leaf Spring

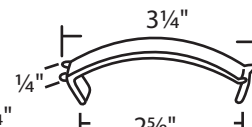
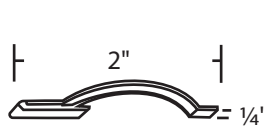
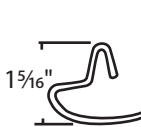

Choose one of the following Fastening Systems:

#087-156BLK Black
 #087-156WHT White
 5/32" Plunger Assembly

#087-157BLK Black
 #087-157WHT White
 5/32" Plunger Assembly
 Flip Type

#087-158BLK Black
 #087-158WHT White
 7/32" Plunger Assembly

#087-159BLK Black
 #087-159WHT White
 7/32" Plunger Assembly
 Flip Type



#087-154 5/32" Dia.
 Fixed Pin

#087-155 7/32" Dia.
 Fixed Pin

#087-311
 Pointer Latch

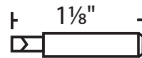
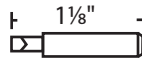

Choose one of the following Corner Keys:

#087-200 White
 Inside Plastic Miter

#087-201BRZ Bronze
 #087-201MILL Mill
 #087-201WHT White
 Outside Plastic
 Straight Cut

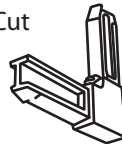

Choose one of the following Pull Tabs:

#087-150BLK Black
 #087-150C Clear
 #087-150WHT White
 Vinyl Pull Tab

#087-151BLK Black Flexible
 #087-153BLK Black Rigid
 Vinyl Pull Tab

#087-152MILL Mill
 #087-150WHT White
 Aluminum Pull Tab

#087-160BLK Black
 #087-160C Clear
 #087-160WHT White
 Vinyl Pull Tab

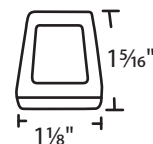
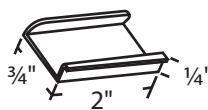
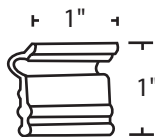
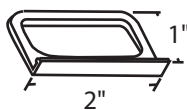

Rolled Form Screen Frames & Parts

- #087-04ALMD Almond
- #087-04BRZ Bronze
- #087-04MILL Mill
- #087-04WHT White
- .019 Gauge 12' 6" Length



- #087-20
.140 Spline



- #087-305
Loop Latch
Double Hung
Hardware

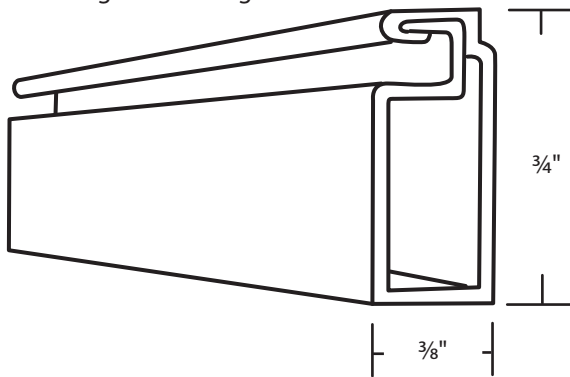
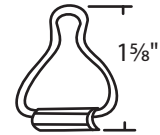

Choose one of the following Springs:

- #087-306
Hairpin Clip

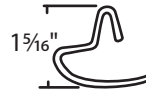

- #087-307
Corner L Spring



- #087-308
Leaf Spring

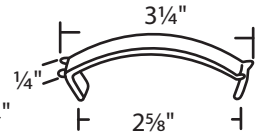

Choose one of the following Fastening Systems:

- #087-156BLK Black
- #087-156WHT White
- 5/32" Plunger Assembly



- #087-154 5/32" Dia.
Fixed Pin

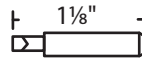

- #087-157BLK Black
- #087-157WHT White
- 5/32" Plunger Assembly
Flip Type

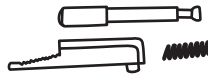

- #087-155 7/32" Dia.
Fixed Pin

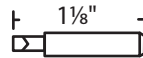

- #087-158BLK Black
- #087-158WHT White
- 7/32" Plunger Assembly



- #087-304 Aluminum
Butterfly Latch

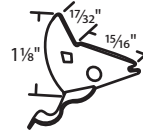

Choose one of the following Corner Keys:

- #087-204 White
Inside Plastic Miter

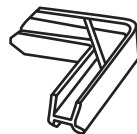

- #087-205ALMD Almond
- #087-205BRZ Bronze
- #087-205MILL Mill
- #087-205WHT White
Outside Plastic
Straight Cut



Choose one of the following Pull Tabs:

- #087-150BLK Black
- #087-150C Clear
- #087-150WHT White
Vinyl Pull Tab

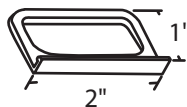

- #087-151BLK Black Flexible
- #087-153BLK Black Rigid
Vinyl Pull Tab

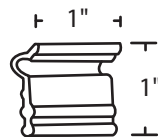

- #087-152MILL Mill
- #087-150WHT White
Aluminum Pull Tab

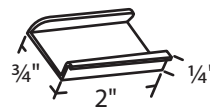

- #087-160BLK Black
- #087-160C Clear
- #087-160WHT White
Vinyl Pull Tab

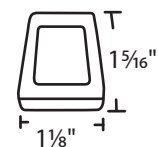





Rolled Form Screen Frames & Parts

- #087-05ALMD Almond
 - #087-05BRZ Bronze
 - #087-05MILL Mill
 - #087-05WHT White
 - .019 Gauge 12' 6" Length
- #087-06ALMD Almond
 - #087-06BRZ Bronze
 - #087-06MILL Mill
 - #087-06WHT White
 - .024 Gauge 12' 6" Length

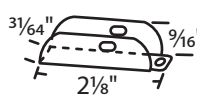
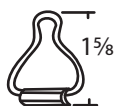

Choose one of the following Double Hung Hardware:



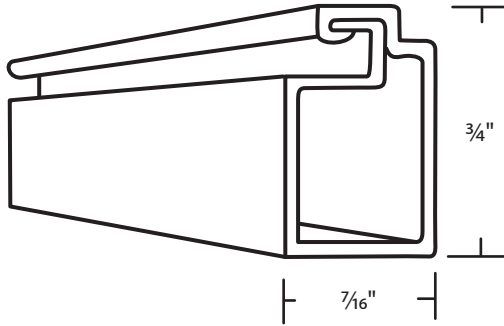

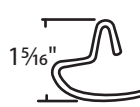
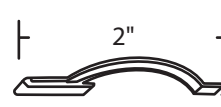
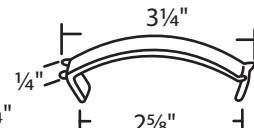

#087-314 	#087-305 Loop Latch 	#087-315 Slip-on Type 
---	--	--



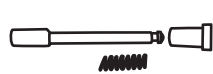

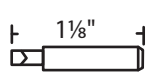
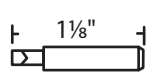
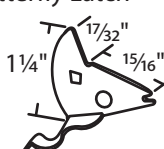

Choose one of the following Springs:

#087-306 Hairpin Clip 	#087-307 Corner L Spring 	#087-308 Leaf Spring 
--	--	---

Choose one of the following Fastening Systems:

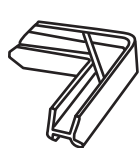
#087-156BLK Black #087-156WHT White 5/32" Plunger Assembly 	#087-157BLK Black #087-157WHT White 5/32" Plunger Assembly Flip Type 	#087-158BLK Black #087-158WHT White 7/32" Plunger Assembly 	#087-159BLK Black #087-159WHT White 7/32" Plunger Assembly Flip Type 
#087-154 5/32" Dia. Fixed Pin 	#087-155 7/32" Dia. Fixed Pin 	#087-304 Aluminum Butterfly Latch 	#087-310 Pointer Latch 

Choose one of the following Corner Keys:

#087-206 White Inside Plastic Miter 	#087-207ALMD Almond #087-207BRZ Bronze #087-207MILL Mill #087-207WHT White Outside Plastic Straight Cut 	#087-208ALMD Almond #087-208BRZ Bronze #087-208MILL Mill #087-208WHT White Outside Miter 	#087-209ALMD Almond #087-209BRZ Bronze #087-209MILL Mill #087-209WHT White Outside Plastic w/ Notch 	#087-210ALMD Almond #087-210BRZ Bronze #087-210MILL Mill #087-210WHT White Outside Plastic w/ Offset 
--	---	---	---	---

Choose one of the following Pull Tabs:

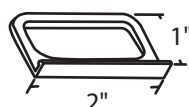
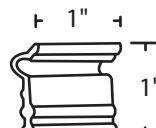
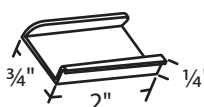
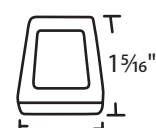
#087-150BLK Black #087-150C Clear #087-150WHT White Vinyl Pull Tab 	#087-151BLK Black Flexible #087-153BLK Black Rigid Vinyl Pull Tab 	#087-152MILL Mill #087-150WHT White Aluminum Pull Tab 	#087-160BLK Black #087-160C Clear #087-160WHT White Vinyl Pull Tab 
---	--	---	---

Rolled Form Screen Frames & Parts

#087-07BRZ Bronze
 #087-07MILL Mill
 #087-07WHT White
 .019 Gauge



#087-20
 .140 Spline

#087-305
 Loop Latch
 Double Hung
 Hardware

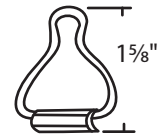
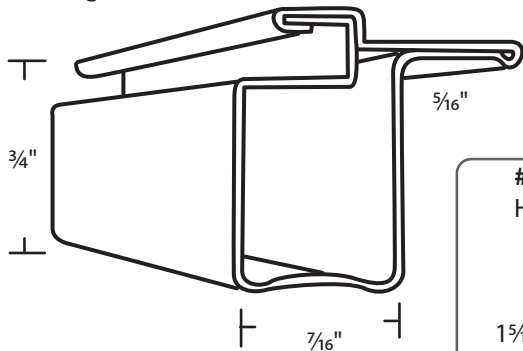

Choose one of the following Springs:

#087-306 Hairpin Clip	#087-307 Corner L Spring	#087-308 Leaf Spring

Choose one of the following Fastening Systems:

#087-156BLK Black #087-156WHT White 5/32" Plunger Assembly	#087-157BLK Black #087-157WHT White 5/32" Plunger Assembly Flip Type	#087-158BLK Black #087-158WHT White 7/32" Plunger Assembly	#087-159BLK Black #087-159WHT White 7/32" Plunger Assembly Flip Type
#087-154 5/32" Dia. Fixed Pin	#087-155 7/32" Dia. Fixed Pin	#087-310 Pointer Latch	

Choose one of the following Corner Keys:

#087-206 White Inside Plastic Miter	#087-207BRZ Bronze #087-207MILL Mill #087-207WHT White Outside Plastic Straight Cut	#087-208BRZ Bronze #087-208MILL Mill #087-208WHT White Outside Miter

Choose one of the following Pull Tabs:

#087-150BLK Black #087-150C Clear #087-150WHT White Vinyl Pull Tab	#087-151BLK Black Flexible #087-153BLK Black Rigid Vinyl Pull Tab	#087-152MILL Mill #087-150WHT White Aluminum Pull Tab	#087-160BLK Black #087-160C Clear #087-160WHT White Vinyl Pull Tab

Rolled Form Screen Frames & Parts

- #087-08ALMD Almond
- #087-08BG Beige
- #087-08BRZ Bronze
- #087-08MILL Mill
- #087-08ST Stone
- #087-08WHT White
- .024 Gauge 12' 6" Length



Choose one of the following Double Hung Hardware:

#087-314
Hanger

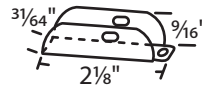

#087-305
Loop Latch

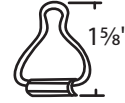

#087-315
Slip-on Type



#087-21
.145 Spline



Choose one of the following Springs:

#087-306
Hairpin Clip

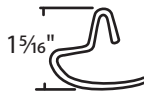

#087-307
Corner L Spring



#087-308
Leaf Spring

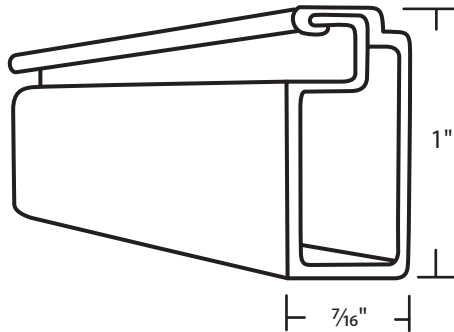
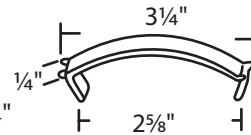

**Fits Andersen Windows
use Outside Corner Keys**

Choose one of the following Fastening Systems:

#087-165BLK Black
#087-165WHT White
5/32" Plunger Assembly



#087-164BLK Black
#087-164WHT White
5/32" Plunger Assembly
Flip Type



#087-309
Butterfly Latch

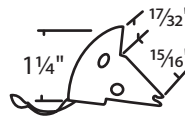

#087-162 5/32" Dia.
Fixed Pin

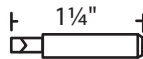

#087-161 7/32" Dia.
Fixed Pin

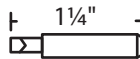

#087-310
Pointer Latch



Choose one of the following Corner Keys:

#087-211 White
Inside Plastic Miter

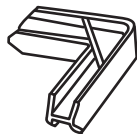

#087-212ALMD Almond
#087-212BRZ Bronze
#087-212MILL Mill
#087-212WHT White
Outside Plastic
Straight Cut



#087-213ALMD Almond
#087-213BRZ Bronze
#087-213MILL Mill
#087-213WHT White
Outside Miter



Choose one of the following Pull Tabs:

#087-150BLK Black
#087-150C Clear
#087-150WHT White
Vinyl Pull Tab

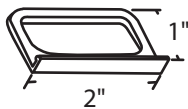

#087-151BLK Black Flexible
#087-153BLK Black Rigid
Vinyl Pull Tab



#087-152MILL Mill
#087-150WHT White
Aluminum Pull Tab

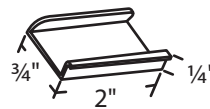

#087-160BLK Black
#087-160C Clear
#087-160WHT White
Vinyl Pull Tab

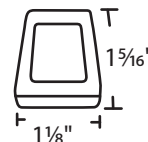

Rolled Form Screen Frames & Parts

- #087-09ALMD Almond
- #087-09BRZ Bronze
- #087-09MILL Mill
- #087-09WHT White
- .019 Gauge 12" 6" Length

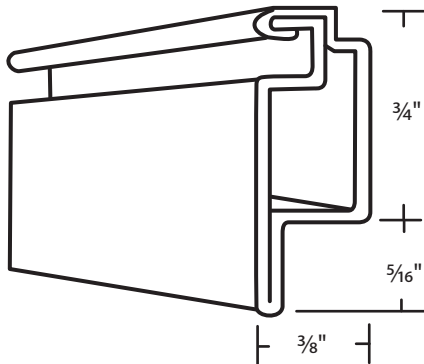

#087-21
.145 Spline



#087-305
Loop Latch
Double Hung
Hardware

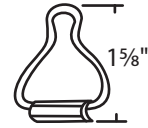

Choose one of the following Springs:

#087-306
Hairpin Clip

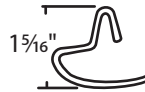

#087-307
Corner L Spring



#087-308
Leaf Spring

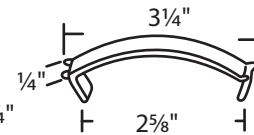

Choose one of the following Fastening Systems:

#087-156BLK Black
#087-156WHT White
5/32" Plunger Assembly



#087-157BLK Black
#087-157WHT White
5/32" Plunger Assembly
Flip Type

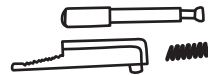

#087-154 5/32" Dia.
Fixed Pin

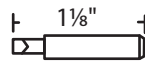

#087-312BLK Black
#087-312WHT White
Pointer Latch

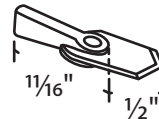

Choose one of the following Corner Keys:

#087-204 White
Inside Plastic Miter

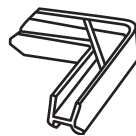

#087-214ALMD Almond
#087-214BRZ Bronze
#087-214MILL Mill
#087-214WHT White
Outside Plastic Flange

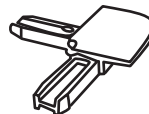

#087-215ALMD Almond
#087-215BRZ Bronze
#087-215MILL Mill
#087-215WHT White
Outside Plastic Flange
w/ Fixed Pin

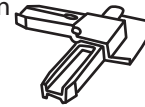

Choose one of the following Pull Tabs:

#087-150BLK Black
#087-150C Clear
#087-150WHT White
Vinyl Pull Tab

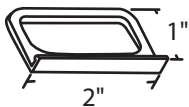

#087-151BLK Black Flexible
#087-153BLK Black Rigid
Vinyl Pull Tab



#087-152MILL Mill
#087-150WHT White
Aluminum Pull Tab

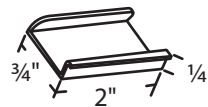

#087-160BLK Black
#087-160C Clear
#087-160WHT White
Vinyl Pull Tab

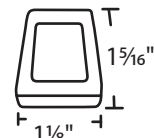

Rolled Form Screen Frames & Parts

#087-10BRZ Bronze
 #087-10MILL Mill
 #087-10WHT White
 Lip .019 Gauge 12' 6" Length

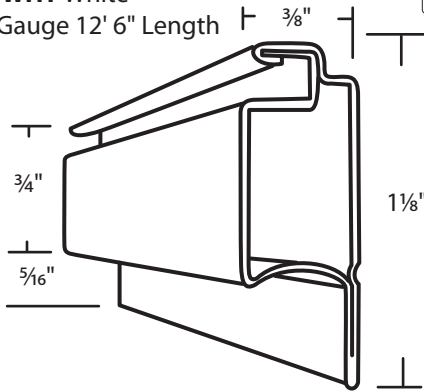

#087-20
 .140 Spline



#087-305
 Loop Latch
 Double Hung
 Hardware

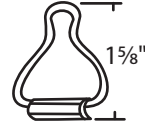

Choose one of the following Corner Keys:

#087-204 White Inside Plastic Miter
 #087-216BRZ Bronze
 #087-216MILL Mill
 #087-216WHT White Outside Plastic Flange

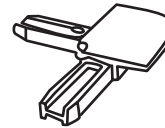
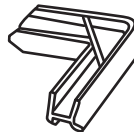

Choose one of the following Fastening Systems:

#087-156BLK Black
 #087-156WHT White
 5/32" Plunger Assembly
 #087-157BLK Black
 #087-157WHT White
 5/32" Plunger Assembly
 Flip Type



#087-154 5/32" Dia.
 Fixed Pin

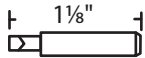

#087-312BLK Black
 #087-312WHT White
 Pointer Latch

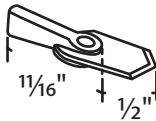

Choose one of the following Springs:

#087-306 Hairpin Clip
 #087-307 Corner L Spring
 #087-308 Leaf Spring

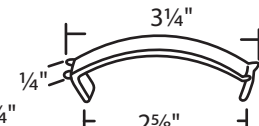
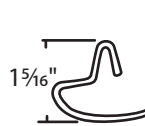

Choose one of the following Pull Tabs:

#087-150BLK Black
 #087-150C Clear
 #087-150WHT White
 Vinyl Pull Tab
 #087-151BLK Black Flexible
 #087-153BLK Black Rigid
 Vinyl Pull Tab
 #087-152MILL Mill
 #087-150WHT White
 Aluminum Pull Tab
 #087-160BLK Black
 #087-160C Clear
 #087-160WHT White
 Vinyl Pull Tab

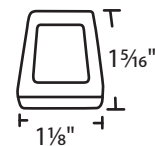
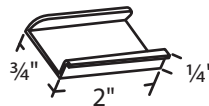
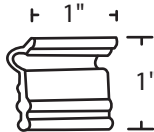
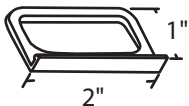

#087-11ALMD Almond
 #087-11BRZ Bronze
 #087-11MILL Mill
 #087-11WHT White
 X-Bar .019 Gauge 12' 6" Length

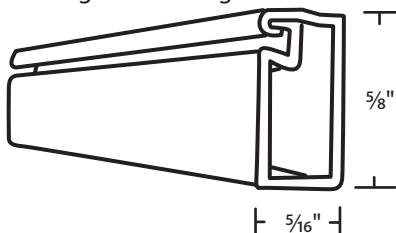

#087-217
 Insert Clip

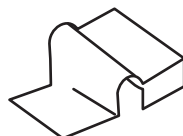

Any questions, call your
 Account Specialist @ 800.842.0974

Rolled Form Screen Frames & Parts



- #087-12ALMD Almond
- #087-12BRZ Bronze
- #087-12MILL Mill
- #087-12WHT White
- .019 Gauge 12' 6" Length

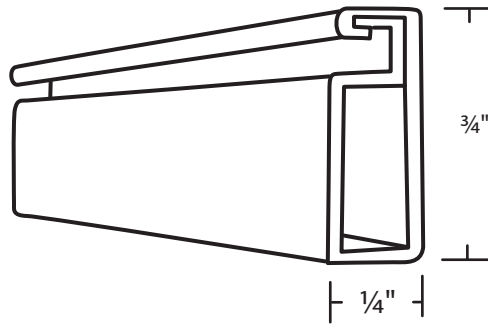

#087-20
.140 Spline



#087-305
Loop Latch
Double Hung
Hardware

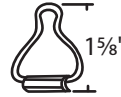

#087-306
Hairpin Clip
Spring

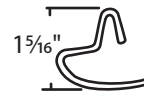

#087-218 White
Inside Plastic Miter
Corner Key

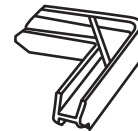

Choose one of the following Fastening Systems:

#087-156BLK Black
#087-156WHT White
5/32" Plunger Assembly



#087-157BLK Black
#087-157WHT White
5/32" Plunger Assembly
Flip Type



#087-154 5/32" Dia.
Fixed Pin

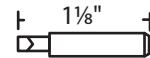

Choose one of the following Pull Tabs:

#087-150BLK Black
#087-150C Clear
#087-150WHT White
Vinyl Pull Tab

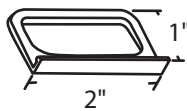

#087-151BLK Black Flexible
#087-153BLK Black Rigid
Vinyl Pull Tab

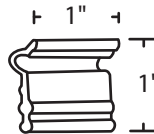

#087-152MILL Mill
#087-150WHT White
Aluminum Pull Tab

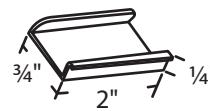

#087-160BLK Black
#087-160C Clear
#087-160WHT White
Vinyl Pull Tab

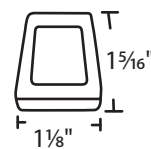

- #087-13BRZ Bronze
- #087-13MILL Mill
- #087-13WHT White
- .019 Gauge

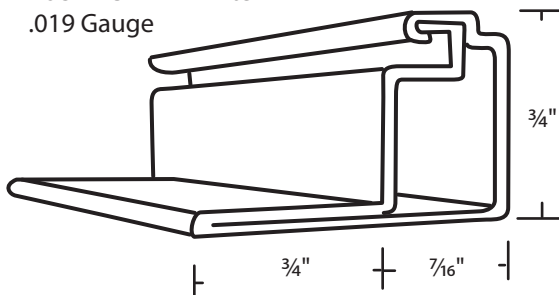

#087-20
.140 Spline



#087-305
Loop Latch
Double Hung
Hardware

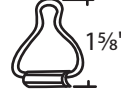

Choose one of the following Corner Keys:

#087-218 White
Inside Plastic Miter

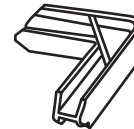

#087-219BLK Black
#087-219WHT White

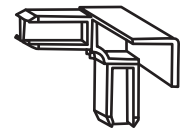

Choose one of the following Springs:

#087-306
Hairpin Clip

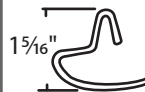

#087-307
Corner L Spring



#087-308
Leaf Spring

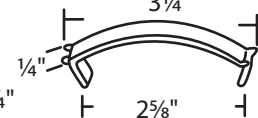

Choose one of the following Pull Tabs:

#087-150BLK Black
#087-150C Clear
#087-150WHT White
Vinyl Pull Tab

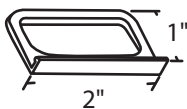

#087-151BLK Black Flexible
#087-153BLK Black Rigid
Vinyl Pull Tab

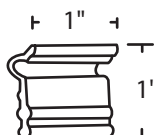

#087-152MILL Mill
#087-150WHT White
Aluminum Pull Tab

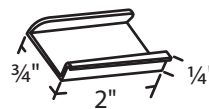

#087-160BLK Black
#087-160C Clear
#087-160WHT White
Vinyl Pull Tab

