

Jambliners



We offer one Tilt Jambliner Profile that will work in place of all discontinued profiles.

New Profile

90L Series - Bracket Type - V Plough

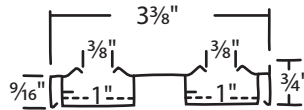

Discontinued Profiles

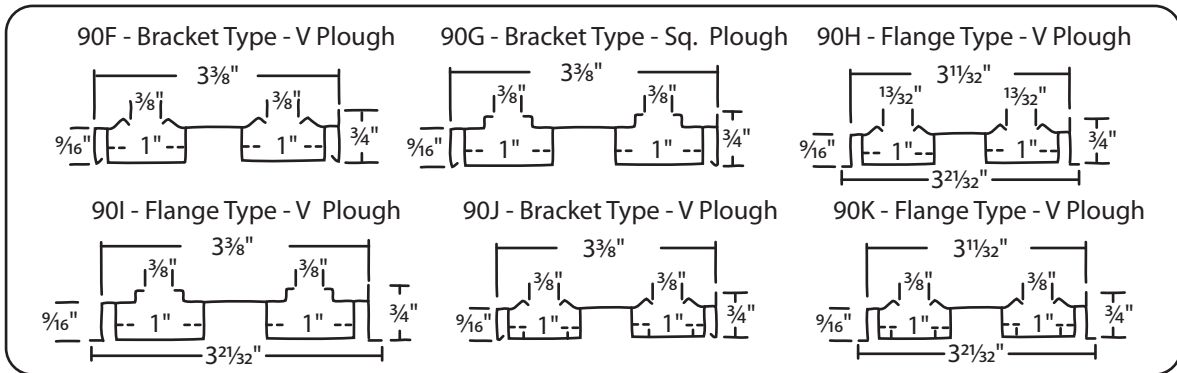

#02-650RH Zinc

#02-649RH Black Plastic
Cam Pivots

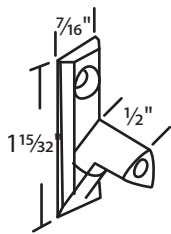

#02-650LH Zinc

#02-650RH White Plastic
Cam Pivots

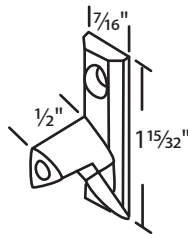

#02-857
Cam Pivots

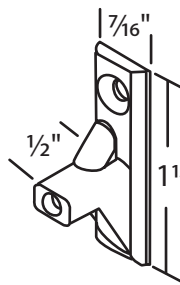

#02-858
Cam Pivots

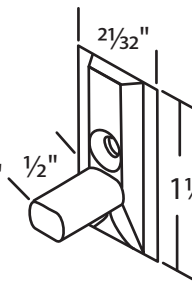

#02-859
Cam Pivots

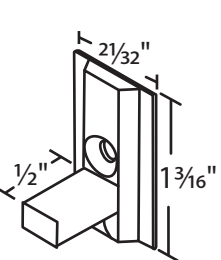

#025-27-1
Caradco

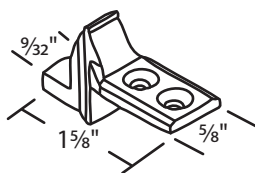

#02-915BG Beige
#02-915W White
Sash Stop

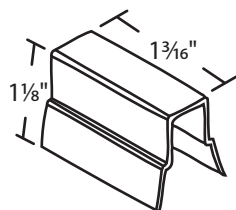

#02-917
Metal
Installation Brackets

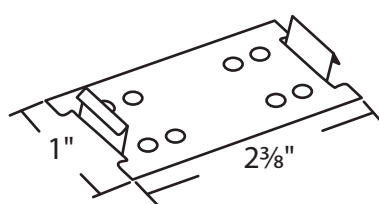

#02-916
Vinyl Release
Installation Brackets

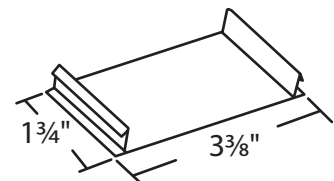

Any questions, call your
Account Specialist @ 800.842.0974

Jambliners



90 Series Part # for Standard Jambliner Sets cut to a standard 15° angle and comes in standard lengths. Each 90 Series Jambliner comes as a set and include the appropriate hardware: brackets #02-971, stops #02-915, & pivot bars #02-650.

Glass Height	Stamp	Balance Length	Sash Weight Capacity	L Bracket Type V Plough White	L Bracket Type V Plough Beige	Length to Longest Pt.
12"	12 REG	13"	8-11 lbs.	05-90-L-1-30W	05-90-L-1-30B	30 ³ / ₈ "
12"	12 HD	13"	12-14 lbs.	05-90-L-2-30W	05-90-L-2-30B	30 ³ / ₈ "
14"	14 REG	15"	10-15 lbs.	05-90-L-1-34W	05-90-L-1-34B	34 ³ / ₈ "
14"	14 HD	15"	15-22 lbs.	05-90-L-2-34W	05-90-L-2-34B	34 ³ / ₈ "
16"	16 REG	17"	10-17 lbs.	05-90-L-1-38W	05-90-L-1-38B	38 ³ / ₈ "
16"	16 HD	17"	17-22 lbs.	05-90-L-2-38W	05-90-L-2-38B	38 ³ / ₈ "
18"	18 REG	19"	10-17 lbs.	05-90-L-1-42W	05-90-L-1-42B	42 ³ / ₈ "
18"	18 HD	19"	17-22 lbs.	05-90-L-2-42W	05-90-L-2-42B	42 ³ / ₈ "
20"	20 REG	21"	10-17 lbs.	05-90-L-1-46W	05-90-L-1-46B	46 ³ / ₈ "
20"	20 HD	21"	17-20 lbs.	05-90-L-2-46W	05-90-L-2-46B	46 ³ / ₈ "
20"	20 TG	21"	20-30 lbs.	05-90-L-3-46W	05-90-L-3-46B	46 ³ / ₈ "
22"	22 REG	23"	10-18 lbs.	05-90-L-1-50W	05-90-L-1-50B	50 ³ / ₈ "
22"	22 HD	23"	18-22 lbs.	05-90-L-2-50W	05-90-L-2-50B	50 ³ / ₈ "
22"	22 TG	23"	22-30 lbs.	05-90-L-3-50W	05-90-L-3-50B	50 ³ / ₈ "
24"	24 REG	25"	10-18 lbs.	05-90-L-1-54W	05-90-L-1-54B	54 ³ / ₈ "
24"	24 HD	25"	18-22 lbs.	05-90-L-2-54W	05-90-L-2-54B	54 ³ / ₈ "
24"	24 TG	25"	22-30 lbs.	05-90-L-3-54W	05-90-L-3-54B	54 ³ / ₈ "
26"	26 REG	27"	10-19 lbs.	05-90-L-1-58W	05-90-L-1-58B	58 ³ / ₈ "
26"	26 HD	27"	19-24lbs.	05-90-L-2-58W	05-90-L-2-58B	58 ³ / ₈ "
26"	26 TG	27"	24-31 lbs.	05-90-L-3-58W	05-90-L-3-58B	58 ³ / ₈ "
28"	28 REG	29"	15-22 lbs.	05-90-L-1-62W	05-90-L-1-62B	62 ³ / ₈ "
28"	28 HD	29"	22-28 lbs.	05-90-L-2-62W	05-90-L-2-62B	62 ³ / ₈ "
28"	28 TG	29"	28-35 lbs.	05-90-L-3-62W	05-90-L-3-62B	62 ³ / ₈ "
30"	30 REG	31"	15-23 lbs.	05-90-L-1-66W	05-90-L-1-66B	66 ³ / ₈ "
30"	30 HD	31"	23-29 lbs.	05-90-L-2-66W	05-90-L-2-66B	66 ³ / ₈ "
30"	30 TG	31"	29-36 lbs.	05-90-L-3-66W	05-90-L-3-66B	66 ³ / ₈ "
32"	32 REG	33"	15-24 lbs.	05-90-L-1-70W	05-90-L-1-70B	70 ³ / ₈ "
32"	32 HD	33"	24-29 lbs.	05-90-L-2-70W	05-90-L-2-70B	70 ³ / ₈ "
32"	32TG	33"	29-36 lbs.	05-90-L-3-70W	05-90-L-3-70B	70 ³ / ₈ "
34"	34 REG	35"	15-24 lbs.	05-90-L-1-74W	05-90-L-1-74B	74 ³ / ₈ "
34"	34 HD	35"	24-29 lbs.	05-90-L-2-74W	05-90-L-2-74B	74 ³ / ₈ "
34"	34 TG	35"	29-36 lbs.	05-90-L-3-74W	05-90-L-3-74B	74 ³ / ₈ "
36"	36 REG	37"	15-24 lbs.	05-90-L-1-78W	05-90-L-1-78B	78 ³ / ₈ "
36"	36 HD	37"	24-29 lbs.	05-90-L-2-78W	05-90-L-2-78B	78 ³ / ₈ "
36"	36 TG	37"	29-38 lbs.	05-90-L-3-78W	05-90-L-3-78B	78 ³ / ₈ "
38"	38 REG	39"	15-24 lbs.	05-90-L-1-82W	05-90-L-1-82B	82 ³ / ₈ "
38"	38 HD	39"	24-29 lbs.	05-90-L-2-82W	05-90-L-2-82B	82 ³ / ₈ "
38"	38 TG	39"	29-38 lbs.	05-90-L-3-82W	05-90-L-3-82B	82 ³ / ₈ "
40"	40 REG	41"	15-25 lbs.	05-90-L-1-86W	05-90-L-1-86B	86 ³ / ₈ "
40"	40 HD	41"	25-30 lbs.	05-90-L-2-86W	05-90-L-2-86B	86 ³ / ₈ "
40"	40 TG	41"	30-38 lbs.	05-90-L-3-86W	05-90-L-3-86B	86 ³ / ₈ "
42"	42 REG	43"	15-25 lbs.	05-90-L-1-90W	05-90-L-1-90B	90 ³ / ₈ "
42"	42 HD	43"	25-30 lbs.	05-90-L-2-90W	05-90-L-2-90B	90 ³ / ₈ "
42"	42 TG	43"	30-38 lbs.	05-90-L-3-90W	05-90-L-3-90B	90 ³ / ₈ "

Any questions, call your Account Specialist @ 800.842.0974

Jambliners



91 & 92 Series **Heavy Duty Magnum Tilt Jambliners** for 1 3/4" Sash

- The choice for historical restoration
- Carries up to an 80 lbs sash
- Sashes over 48" and 50lbs. has limited travel
- Offered for both single and double hung windows

91 Series - Bracket Type

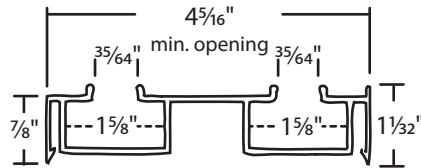

92 Series - Bracket Type

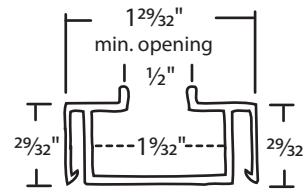

Series 91 & 92 Magnum is custom made and therefore, non-returnable.

Please fill-out the following:

1. Circle one:
Single Hung or Double Hung
2. Circle one:
White or Beige
3. Circle one:
Sill angle-square cut 15°, 14°, 7°, 5°, other _____
4. Visible Glass Height of:
Top Sash _____ Top Sash Weight _____
5. Visible Glass Height of:
Bottom Sash _____ Bottom Sash Weight _____
6. Glass Width (top & bottom same) _____
7. Overall Length to Longest Point _____ Shortest Point _____

Hardware is included w/ purchase of jambliner set, but also sold seperately.

Jambliner set includes (2) RH & LH pivots, (2) sash stops and (2) retainers for the lower sash.

#05-160
Cam Pivot

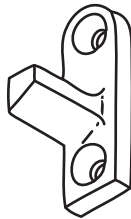

#05-161
Cam Pivot



#02-915BG Beige
#02-915W White
Sash Stop

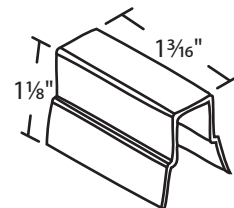

#05-162BG Biege
#05-162W White
Sash Retainer

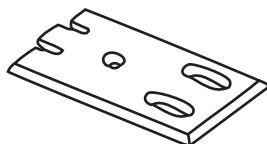

#05-163
Single Hung Bracket
Installation Bracket

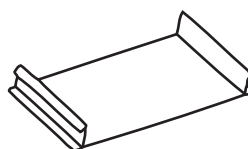

#05-164
Double Hung Bracket
Installation Bracket

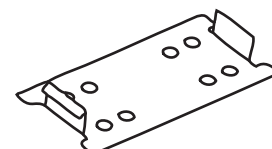

Any questions, call your Account Specialist @ **800.842.0974**

Jambliners



Non-Tilt Jambliners
 For Single Strength Glass
 704A Series for 1 3/8" Sash
 704B Series for 1 1/4" Sash

704A Series

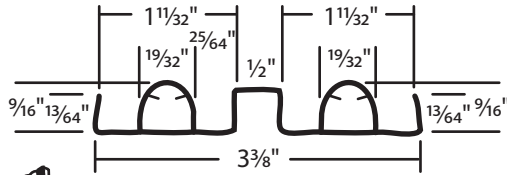

704B Series

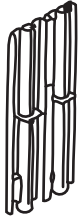
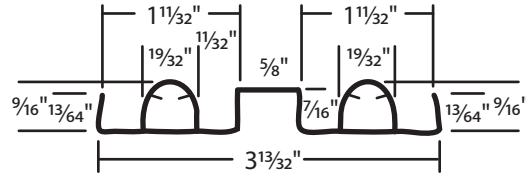

#01-704-701
 Beige Metal
 Jambliner Sash Stop

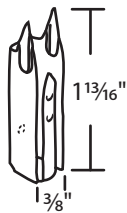

Glass Size	Opening Height	704A Beige Part #	704A White Part #	704B Beige Part #	704B White Part #	Max. Sash Weight	Length to Longest Pt.
12"	2-6 - 30"	01-704-30A-1	01-704-30A-2	01-704-30B-1	01-704-30B-2	7.8 lbs	30 3/16"
14"	2-10 - 34"	01-704-34A-1	01-704-34A-2	01-704-34B-1	01-704-34B-2	8.5 lbs	34 3/16"
16"	3-2 - 38"	01-704-38A-1	01-704-38A-2	01-704-38B-1	01-704-38B-2	9.2 lbs	38 3/16"
18"	3-6 - 42"	01-704-42A-1	01-704-42A-2	01-704-42B-1	01-704-42B-2	9.9 lbs	42 3/16"
20"	3-10 - 46"	01-704-46A-1	01-704-46A-2	01-704-46B-1	01-704-46B-2	10.6 lbs	46 3/16"
22"	4-2 - 50"	01-704-50A-1	01-704-50A-2	01-704-50B-1	01-704-50B-2	11.3 lbs	50 3/16"
24"	4-6 - 54"	01-704-54A-1	01-704-54A-2	01-704-54B-1	01-704-54B-2	12.0 lbs	54 3/16"
26"	4-10 - 58"	01-704-58A-1	01-704-58A-2	01-704-58B-1	01-704-58B-2	12.7 lbs	58 3/16"
28"	5-2 - 62"	01-704-62A-1	01-704-62A-2	01-704-62B-1	01-704-62B-2	13.4 lbs	62 3/16"
30"	5-6 - 66"	01-704-66A-1	01-704-66A-2	01-704-66B-1	01-704-66B-2	14.1 lbs	66 3/16"
32"	5-10 - 70"	01-704-70A-1	01-704-70A-2	01-704-70B-1	01-704-70B-2	14.8 lbs	70 3/16"
34"	6-2 - 74"	01-704-74A-1	01-704-74A-2	01-704-74B-1	01-704-74B-2	15.5 lbs	74 3/16"
36"	6-6 - 78"	01-704-78A-1	01-704-78A-2	01-704-78B-1	01-704-78B-2	15.5 lbs	78 3/16"

Non-Tilt Jambliners
 For Insulated or Double Strength Glass
 704C Series for 1 3/8" Sash
 704D Series for 1 1/4" Sash

Full Cartons contain
 30 sets per box.
 Only comes in Beige
 14° Standard Sill Angle

704C Series

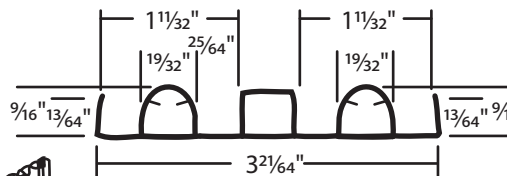

704D Series

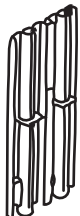
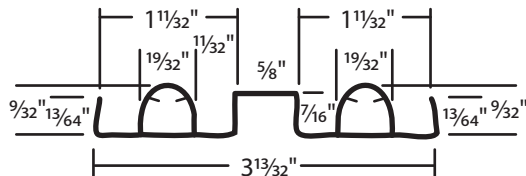

#01-704-701
 Beige Metal
 Jambliner Sash Stop

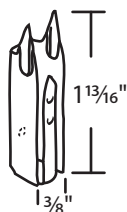

Glass Size	Opening Height	704C Beige Part #	704C White Part #	704D Beige Part #	704D White Part #	Max. Sash Weight	Length to Longest Pt.
12"	2-6 - 30"	01-704-30C-1	01-704-30C-2	01-704-30D-1	02-704-30D-2	11.0 lbs	30 3/16"
14"	2-10 - 34"	01-704-34C-1	01-704-34C-2	01-704-34D-1	02-704-34D-2	12.3 lbs	34 3/16"
16"	3-2 - 38"	01-704-38C-1	01-704-38C-2	01-704-38D-1	02-704-38D-2	13.5 lbs	38 3/16"
18"	3-6 - 42"	01-704-42C-1	01-704-42C-2	01-704-42D-1	02-704-42D-2	14.8 lbs	42 3/16"
20"	3-10 - 46"	01-704-46C-1	01-704-46C-2	01-704-46D-1	02-704-46D-2	16.0 lbs	46 3/16"
22"	4-2 - 50"	01-704-50C-1	01-704-50C-2	01-704-50D-1	02-704-50D-2	17.3 lbs	50 3/16"
24"	4-6 - 54"	01-704-54C-1	01-704-54C-2	01-704-54D-1	02-704-54D-2	18.5 lbs	54 3/16"
26"	4-10 - 58"	01-704-58C-1	01-704-58C-2	01-704-58D-1	02-704-58D-2	19.9 lbs	58 3/16"
28"	5-2 - 62"	01-704-62C-1	01-704-62C-2	01-704-62D-1	02-704-62D-2	21.0 lbs	62 3/16"
30"	5-6 - 66"	01-704-66C-1	01-704-66C-2	01-704-66D-1	02-704-66D-2	22.2 lbs	66 3/16"
32"	5-10 - 70"	01-704-70C-1	01-704-70C-2	01-704-70D-1	02-704-70D-2	23.5 lbs	70 3/16"
34"	6-2 - 74"	01-704-74C-1	01-704-74C-2	01-704-74D-1	02-704-74D-2	24.7 lbs	74 3/16"
36"	6-6 - 78"	01-704-78C-1	01-704-78C-2	01-704-78D-1	02-704-78D-2	26.0 lbs	78 3/16"

Call your Account Specialist
 @ 800.842.0974 for special sizes