

31 Series



Coil Spring Roller-Tilt Balance

How to Order:

- Determine weight of balances needed based on sash weight or stamp on coil spring.
 - Pick the appropriate locking collar color.
- Balance accessories on pp.

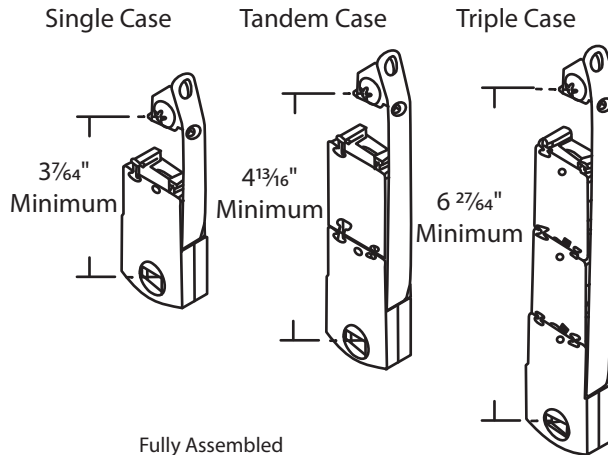
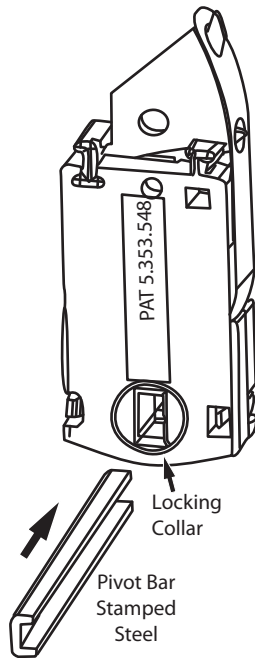

Fully Assembled

Lbs	Blue Collar	Black Collar	Red Collar
3	01-31-1A-3-1	01-31-1A-3-2	01-31-1A-3-3
4	01-31-1A-4-1	01-31-1A-4-2	01-31-1A-4-3
5	01-31-1A-5-1	01-31-1A-5-2	01-31-1A-5-3
6	01-31-1A-6-1	01-31-1A-6-1	01-31-1A-6-3
7	01-31-1A-7-1	01-31-1A-7-2	01-31-1A-7-3
8	01-31-1A-8-1	01-31-1A-8-2	01-31-1A-8-3
9	01-31-1A-9-1	01-31-1A-9-2	01-31-1A-9-3
10	01-31-1A-10-1	01-31-1A-10-2	01-31-1A-10-3

Fully Assembled

Lbs	Tandem/Triple Case
3	01-31/32-3T
4	01-31/32-4T
5	01-31/32-5T
6	01-31/32-6T
7	01-31/32-7T
8	01-31/32-8T
9	01-31/32-9T
10	01-31/32-10T

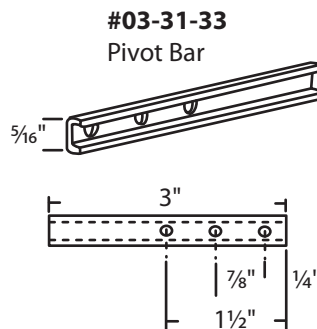
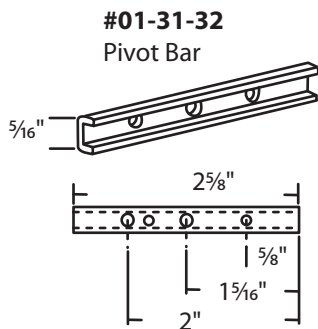

#01-31-15 Blue A = 3/32"
#01-31-16 Black A = 7/64"
#01-31-17 Red A = 1/8"
 Locking Collar



Any questions, call your
Account Specialist @ **800.842.0974**

32 Series



Coil Spring Roller-Tilt Tie In Balance

How to Order:

- Determine weight of balances needed based on sash weight or stamp on coil spring.
- Pick appropriate depth
- Pick the appropriate color of collar
- Balance accessories on pp.

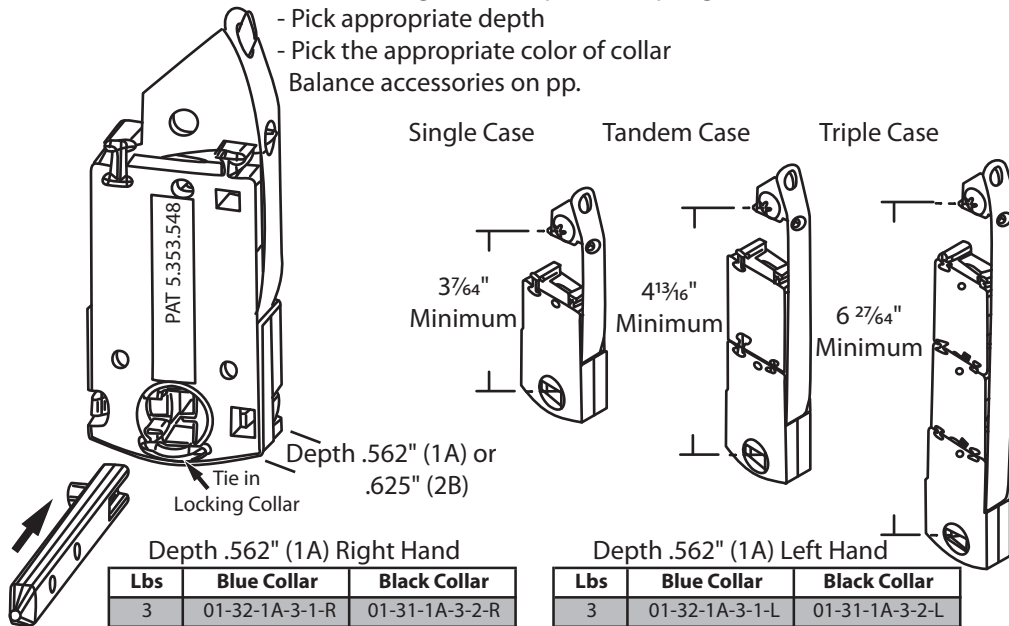

Depth .562" (1A) Right Hand

Lbs	Blue Collar	Black Collar
3	01-32-1A-3-1-R	01-31-1A-3-2-R
4	01-32-1A-4-1-R	01-32-1A-4-2-R
5	01-32-1A-5-1-R	01-32-1A-5-2-R
6	01-32-1A-6-1-R	01-32-1A-6-1-R
7	01-32-1A-7-1-R	01-32-1A-7-2-R
8	01-32-1A-8-1-R	01-32-1A-8-2-R
9	01-32-1A-9-1-R	01-32-1A-9-2-R
10	01-32-1A-10-1-R	01-32-1A-10-2-R

Depth .562" (1A) Left Hand

Lbs	Blue Collar	Black Collar
3	01-32-1A-3-1-L	01-31-1A-3-2-L
4	01-32-1A-4-1-L	01-32-1A-4-2-L
5	01-32-1A-5-1-L	01-32-1A-5-2-L
6	01-32-1A-6-1-L	01-32-1A-6-1-L
7	01-32-1A-7-1-L	01-32-1A-7-2-L
8	01-32-1A-8-1-L	01-32-1A-8-2-L
9	01-32-1A-9-1-L	01-32-1A-9-2-L
10	01-32-1A-10-1-L	01-32-1A-10-2-L

Depth .625" (2B) Right Hand

Lbs	Blue Collar	Black Collar
3	01-32-2B-3-1-R	01-31-2B-3-2-R
4	01-32-2B-4-1-R	01-32-2B-4-2-R
5	01-32-2B-5-1-R	01-32-2B-5-2-R
6	01-32-2B-6-1-R	01-32-2B-6-1-R
7	01-32-2B-7-1-R	01-32-2B-7-2-R
8	01-32-2B-8-1-R	01-32-2B-8-2-R
9	01-32-2B-9-1-R	01-32-2B-9-2-R
10	01-32-2B-10-1-R	01-32-2B-10-2-R

Depth .625" (2B) Left Hand

Lbs	Blue Collar	Black Collar
3	01-32-2B-3-1-L	01-31-2B-3-2-L
4	01-32-2B-4-1-L	01-32-2B-4-2-L
5	01-32-2B-5-1-L	01-32-2B-5-2-L
6	01-32-2B-6-1-L	01-32-2B-6-1-L
7	01-32-2B-7-1-L	01-32-2B-7-2-L
8	01-32-2B-8-1-L	01-32-2B-8-2-L
9	01-32-2B-9-1-L	01-32-2B-9-2-L
10	01-32-2B-10-1-L	01-32-2B-10-2-L

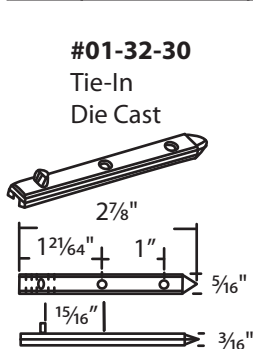

Fully Assembled Tandem/Triple Case

Lbs	Tandem/Triple Case
3	01-31/32-3T
4	01-31/32-4T
5	01-31/32-5T
6	01-31/32-6T
7	01-31/32-7T
8	01-31/32-8T
9	01-31/32-9T
10	01-31/32-10T

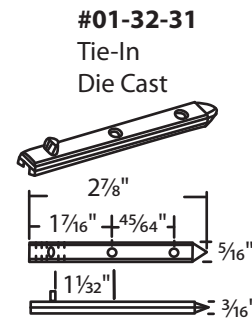

#01-32-18 Blue A = 3/32"
#01-32-19 Black A = 7/64"

Tie-In Locking Collar



31 & 32 Series Accesories



Coil Spring Balance

Single Case

Tandem Case

Triple Case

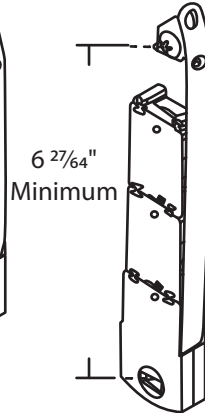
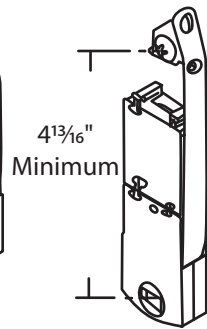
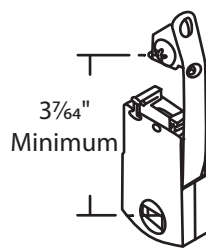

- #01-31-03 Spring Capacity #3
- #01-31-04 Spring Capacity #4
- #01-31-05 Spring Capacity #5
- #01-31-06 Spring Capacity #6
- #01-31-07 Spring Capacity #7
- #01-31-08 Spring Capacity #8
- Stainless Steel Coil Spring

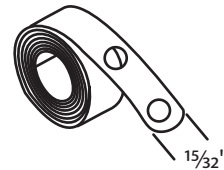

#01-31-11
Locking Case Half

#01-31-12
Locking Case Half
Shown #01-31-12
& #01-31-11
for Tie in Bar

#01-31-13
Locking Case Half

#01-31-14
Locking Case Half
Use to make tandem &
triple case assembly

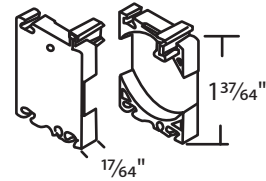
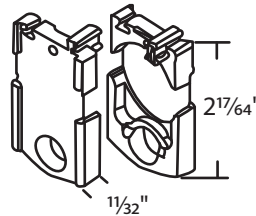
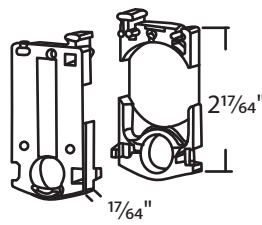
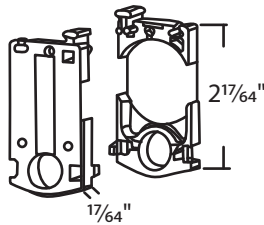

#01-32-30
Tie-In
Die Cast

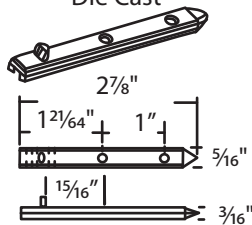

#01-32-31
Tie-In
Die Cast

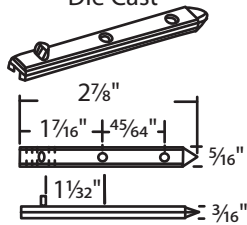

#01-31-24
Anti Debris Wiper

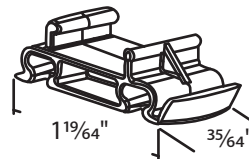

#01-31-25
Cover

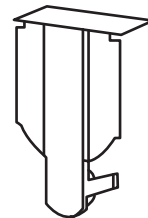

#01-31-32
Pivot Bar

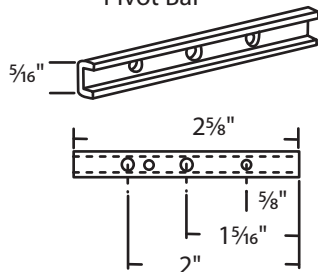

#03-31-33
Pivot Bar

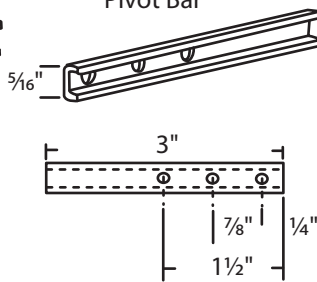

- #01-31-26 Orange A = 3 7/64"
- #01-31-27 Navy Blue A = 3/16"
- #01-31-28 Black A = 3 39/64"
- #01-31-29 Natural A = 3 35/64"

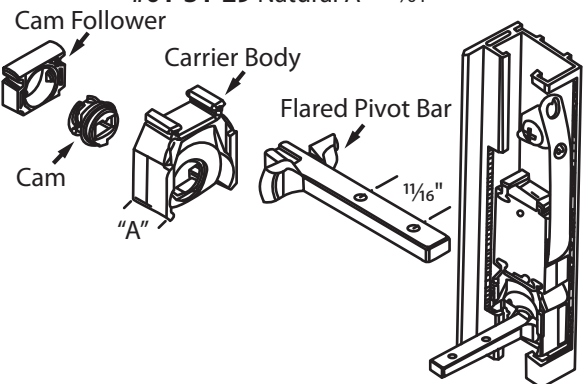

Any questions, call your
Account Specialist @ **800.842.0974**

Continue to the next page for additional accessories

31 & 32 Series Accesories



#01-31-20
White



#01-31-21
White

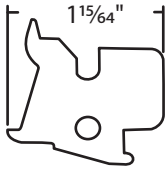

#01-31-15 Blue A = 3/32"
#01-31-16 Black A = 7/64"
#01-31-17 Red A = 1/8"
Locking Collar



#01-32-18 Blue A = 3/32"
#01-32-19 Black A = 7/64"
Tie-In Locking Collar



#01-31-10
Drum

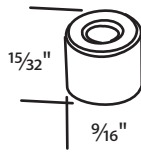

#01-31-22
#8 Pan Head
3/8" Long
Mounting Screw



#01-31-23
6-32 x 1/4" Friction
Adjustment Screw



Thank You
for Using Our Services!

Your Satisfaction
is Important to Us!

Any questions, call your
Account Specialist @ 800.842.0974

37 Series

Coil Spring Balance

New Style

#01-401
Triple Cover

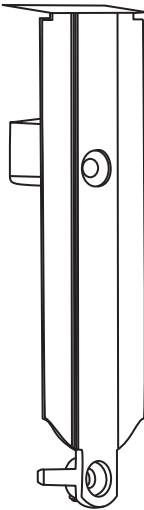

#01-403
Tandem Cover

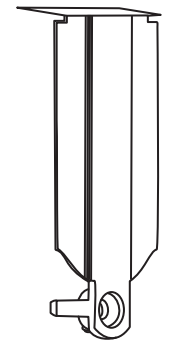

#01-404
Single Cover

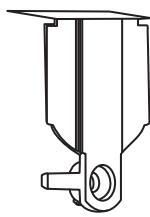

Single



Double

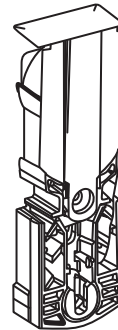

Triple



#01-417
Friction Adjuster



#01-405
Spring Mount
Used for 3 to
8 lb springs

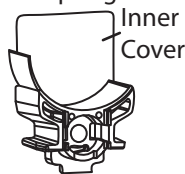

#01-406
Spring Mount
Used for 9 lb springs

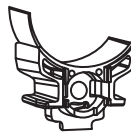

#01-407
Bumper



#01-411
Up to 20 lbs
#01-411HD
Over 20 lbs

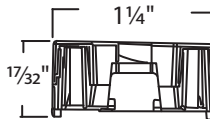

#01-412
Up to 20 lbs
#01-412HD
Over 20 lbs

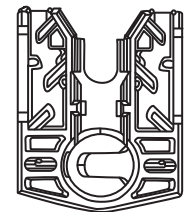
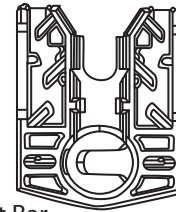
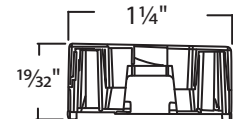

Tamper Lock
NLA



#01-413
Tamper Lock



#01-414
Old Style
NLA

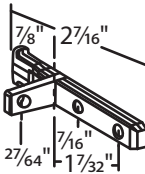

#01-414
New Style
Round Head Pivot Bar

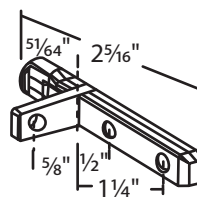

Old Styles
NLA

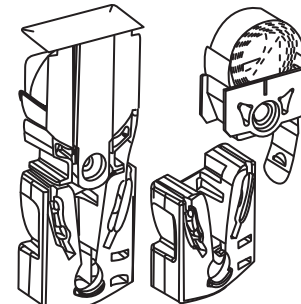

#01-415
Old Style
NLA

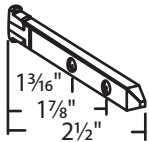

#01-415
New Style
Round Head Pivot Bar

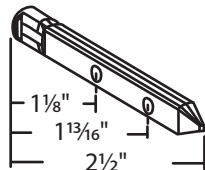

Old Style
NLA

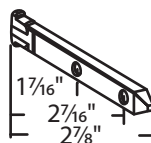

#01-416

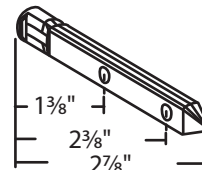

Any questions, call your
Account Specialist @ **800.842.0974**



37 Series



QuickTilt® nc Coil Spring Balance System sold as complete set only

#01-411
Up to 20 lbs
#01-411HD
Over 20 lbs

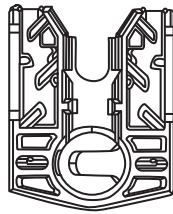
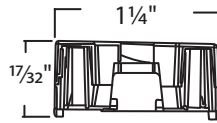

#01-412
Up to 20 lbs
#01-412HD
Over 20 lbs

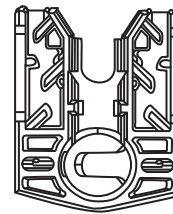
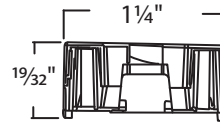

#01-411		
SPRING	WEIGHT	WRS PART#
SINGLE	3 LB COVER ASM RH	01-37-01
SINGLE	4 LB COVER ASM RH	01-37-02
SINGLE	5 LB COVER ASM RH	01-37-03
SINGLE	6 LB COVER ASM RH	01-37-04
SINGLE	7 LB COVER ASM RH	01-37-05
SINGLE	8 LB COVER ASM RH	01-37-06
SINGLE	9 LB COVER ASM RH	01-37-07
SINGLE	3 LB COVER ASM LH	01-37-08
SINGLE	4 LB COVER ASM LH	01-37-09
SINGLE	5 LB COVER ASM LH	01-37-10
SINGLE	6 LB COVER ASM LH	01-37-11
SINGLE	7 LB COVER ASM LH	01-37-12
SINGLE	8 LB COVER ASM LH	01-37-13
SINGLE	9 LB COVER ASM LH	01-37-14
TANDEM	8 LB COVER ASM	01-37-15
TANDEM	9 LB COVER ASM	01-37-16
TANDEM	10 LB COVER ASM	01-37-17
TANDEM	11 LB COVER ASM	01-37-18
TANDEM	12 LB COVER ASM	01-37-19
TANDEM	13 LB COVER ASM	01-37-20
TANDEM	14 LB COVER ASM	01-37-21
TANDEM	15 LB COVER ASM	01-37-22
TANDEM	16 LB COVER ASM	01-37-23
TRIPLE	17 LB COVER ASM	01-37-24
TRIPLE	18 LB COVER ASM	01-37-25
TRIPLE	19 LB COVER ASM	01-37-26
TRIPLE	20 LB COVER ASM	01-37-27
TRIPLE	21 LB COVER ASM	01-37-28
TRIPLE	22 LB COVER ASM	01-37-29
TRIPLE	23 LB COVER ASM	01-37-30
TRIPLE	24 LB COVER ASM	01-37-31
TRIPLE	25 LB COVER ASM	01-37-32
TRIPLE	26 LB COVER ASM	01-37-33
TRIPLE	27 LB COVER ASM	01-37-34

#01-412		
SPRING	WEIGHT	WRS PART#
SINGLE	3 LB COVER ASM RH	01-37-35
SINGLE	4 LB COVER ASM RH	01-37-36
SINGLE	5 LB COVER ASM RH	01-37-37
SINGLE	6 LB COVER ASM RH	01-37-38
SINGLE	7 LB COVER ASM RH	01-37-39
SINGLE	8 LB COVER ASM RH	01-37-40
SINGLE	9 LB COVER ASM RH	01-37-41
SINGLE	3 LB COVER ASM LH	01-37-42
SINGLE	4 LB COVER ASM LH	01-37-43
SINGLE	5 LB COVER ASM LH	01-37-44
SINGLE	6 LB COVER ASM LH	01-37-45
SINGLE	7 LB COVER ASM LH	01-37-46
SINGLE	8 LB COVER ASM LH	01-37-47
SINGLE	9 LB COVER ASM LH	01-37-48
TANDEM	8 LB COVER ASM	01-37-49
TANDEM	9 LB COVER ASM	01-37-50
TANDEM	10 LB COVER ASM	01-37-51
TANDEM	11 LB COVER ASM	01-37-52
TANDEM	12 LB COVER ASM	01-37-53
TANDEM	13 LB COVER ASM	01-37-54
TANDEM	14 LB COVER ASM	01-37-55
TANDEM	15 LB COVER ASM	01-37-56
TANDEM	16 LB COVER ASM	01-37-57
TRIPLE	17 LB COVER ASM	01-37-58
TRIPLE	18 LB COVER ASM	01-37-59
TRIPLE	19 LB COVER ASM	01-37-60
TRIPLE	20 LB COVER ASM	01-37-61
TRIPLE	21 LB COVER ASM	01-37-62
TRIPLE	22 LB COVER ASM	01-37-63
TRIPLE	23 LB COVER ASM	01-37-64
TRIPLE	24 LB COVER ASM	01-37-65
TRIPLE	25 LB COVER ASM	01-37-66
TRIPLE	26 LB COVER ASM	01-37-67
TRIPLE	27 LB COVER ASM	01-37-68

Any questions, call your Account Specialist @ **800.842.0974**

77 Series

Coil Spring Balance System

#05-77-09

Universal Single Support

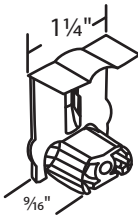

#05-77-10

Universal Dual Support

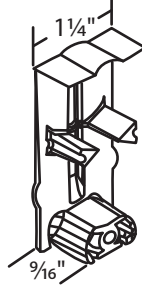

#05-77-11

Universal Triple Support

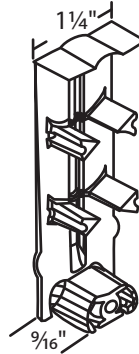

#05-77-12

Universal Quad Support

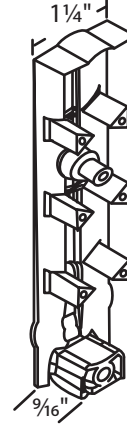

WRS Part #	Weight
05-77-03	3.5
05-77-04	4.5
05-77-05	5.5
05-77-06	6.5
05-77-07	7.5
05-77-08	9

Universal Spring

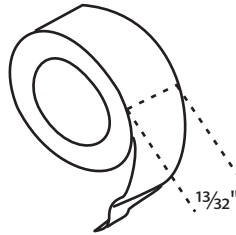

#05-77-13
Side-Locking

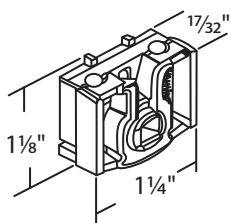

#05-77-14
Back-Locking

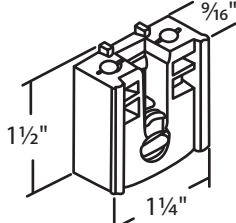

#05-77-15
Side-Locking

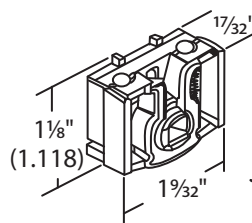

#05-77-16
Side-Locking
Super Tough Nylon

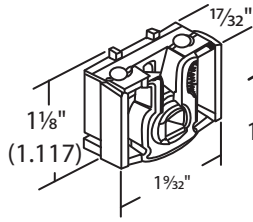

#05-77-17
Back-Locking

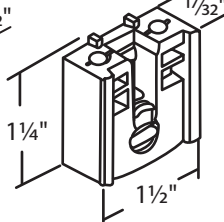

05-77-18
Side-Locking

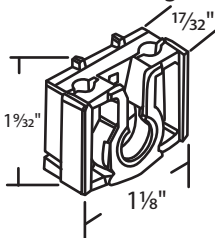

#05-77-19
Back-Locking

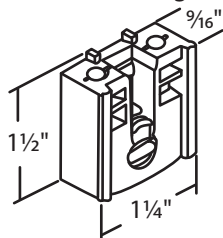

#05-77-27
Side-Locking

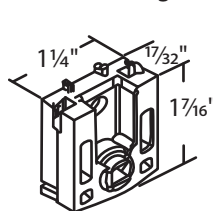

#05-77-20
T-Pivot

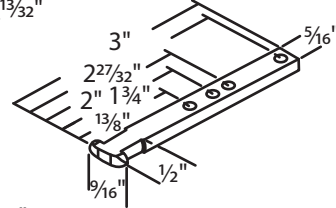

#05-77-26
Pivot Retainer
Supa Lock



#05-77-22
T-Pivot

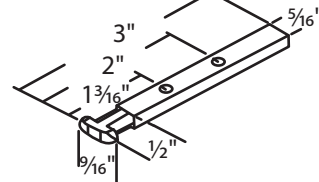

#05-77-25
Pivot Retainer Clip



#05-77-23
T-Pivot

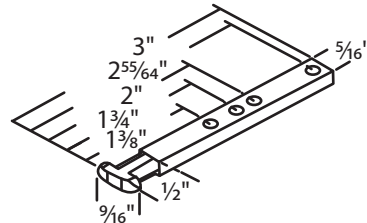

#05-77-28
Shim

#05-77-24
Transit Pivot Bar

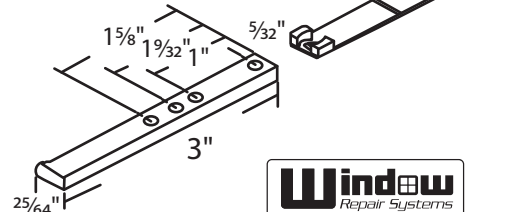

96 Series



Coil Spring Balance

Short Tongue, 3/4" Wide

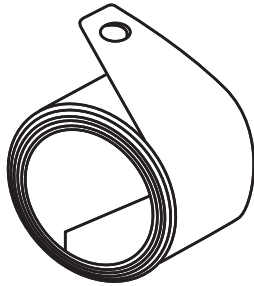

#02-96-C1
Old Style—NLA
Plastic Cam

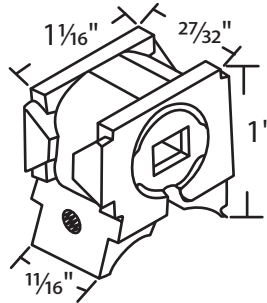

#02-96-C1
New Style
Metal Cam
Cam Opening: 19/64" x 3/16"

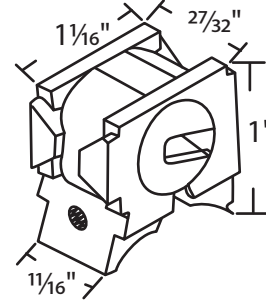

# ON SPRING	WEIGHT	WRS PART#
263-S	3 lbs	02-96-C263
334-S	4 lbs	02-96-C334
335-S	5 lbs	02-96-C335
405-S	5 lbs	02-96-C405
336-S	6 lbs	02-96-C336
406-S	6 lbs	02-96-C406
407-S	7 lbs	02-96-C407
408-S	8 lbs	02-96-C408

#02-96-C2
Drum Barrel
Dia. 3/8" Wide
Certainteed

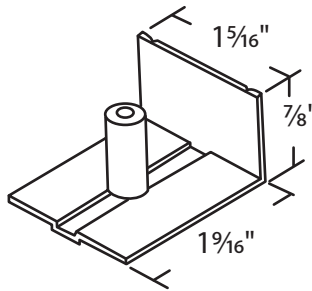

#02-96-C8
Drum Barrel
Dia. 3/8" Wide
Certainteed

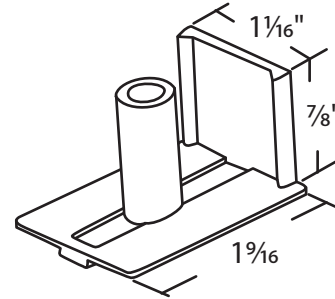

Long Tongue, 3/4" Wide

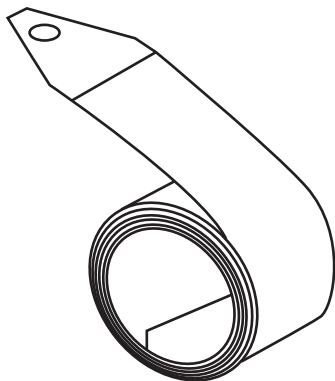

#02-96C6
Opposite
#02-96-C7
Shown

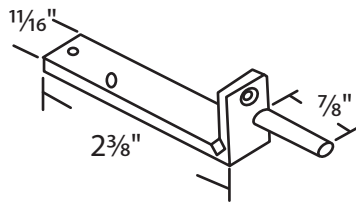

#072-97
Pivot Bar

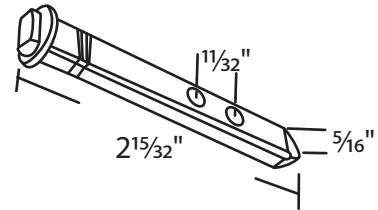

#02-956
Milled
#02-956WHT
White



#02-96-C3
Balance Drum

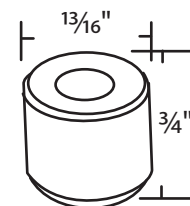

# ON SPRING	WEIGHT	WRS PART#
405-L	5 lbs	02-96-C405A
406-L	6 lbs	02-96-C406A
407-L	7 lbs	02-96-C407A

330 & 331 Series



Coil Spring Balance System

#030-330-XX
Old Style
NLA

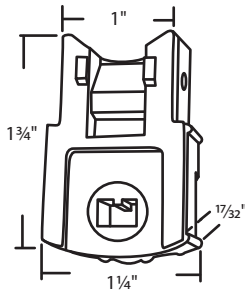

WRS PART #	SINGLE OR DOUBLE COIL	# STAMPED ON COIL
030-330-01	SINGLE	355
030-330-02	SINGLE	440
030-330-03	SINGLE	5 OR 540
030-330-04	SINGLE	6 OR 640
030-330-05	SINGLE	7 OR 740
030-330-06	SINGLE	8 OR 840
030-330-07	SINGLE	832
030-330-08	DOUBLE	335/335
030-330-09	DOUBLE	440/440
030-330-10	DOUBLE	440/540
030-330-11	DOUBLE	540/540
030-330-12	DOUBLE	540/590
030-330-13	DOUBLE	540/640
030-330-14	DOUBLE	640/640
030-330-15	DOUBLE	740/740
030-330-16	DOUBLE	840/840

#030-330-XX
New Style

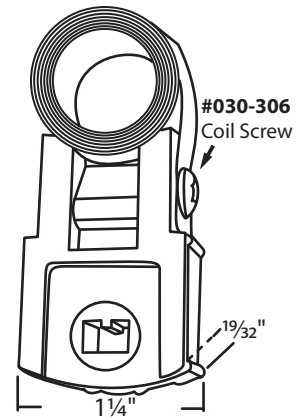

#030-301
Bushing

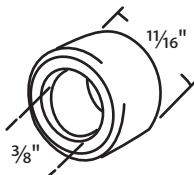

- Dark Gray 2 1/32"
- Black 2 1/32"
- Bronze 4 1/64"
- Gray 1 1/16"
- Tan 4 1/64"
- White 4 3/64"

WRS PART #	SINGLE OR DOUBLE COIL	# STAMPED ON COIL
030-331-17	SINGLE	5 OR 540
030-331-18	SINGLE	6 OR 640
030-331-19	SINGLE	7 OR 740
030-331-20	SINGLE	8 OR 840
030-331-21	SINGLE	842
030-331-22	DOUBLE	440/440
030-331-23	DOUBLE	440/540
030-331-24	DOUBLE	540/540
030-331-25	DOUBLE	540/640
030-331-26	DOUBLE	640/640
030-331-27	DOUBLE	740/740

#030-331-XX

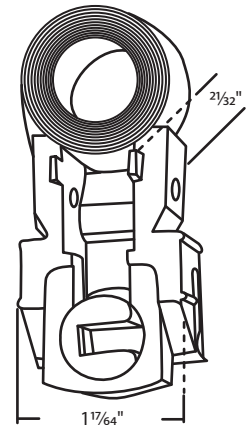

#303-302
Clip

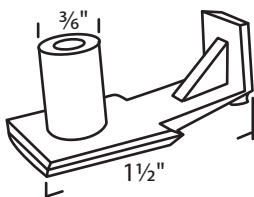

#030-302-2
Detent Clip

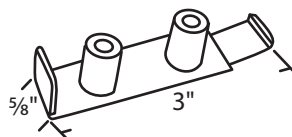

#030-303
Guide

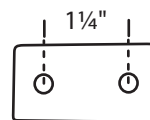

#030-304
Universal Pivot Bar

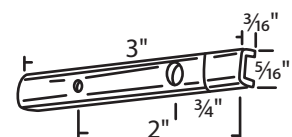

Any questions, call your Account Specialist @ 800.842.0974