

Misc. Parts

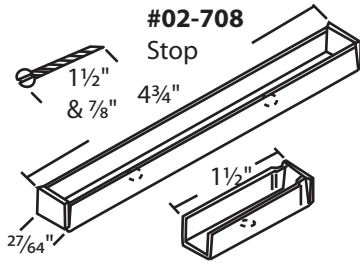

#02-5202 White  
#02-2511 Black

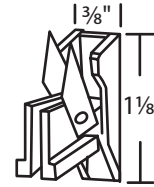

Sorted by length of bracket

Brackets

#02-5236

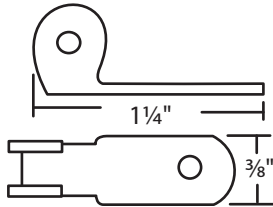

#02-943

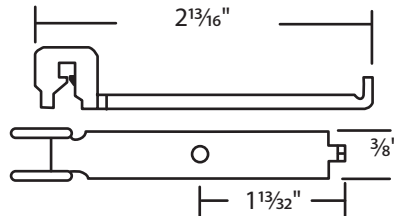

#02-943

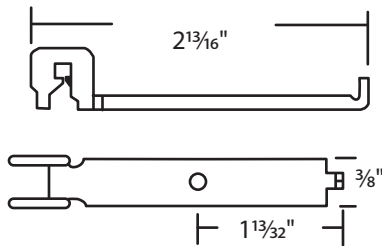

#01-14

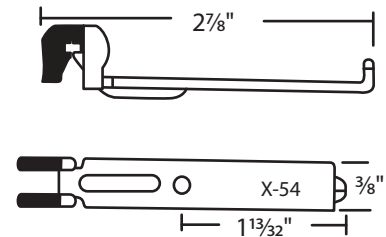

#01-13

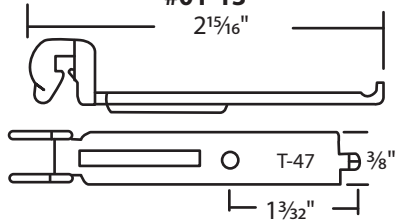

#01-10

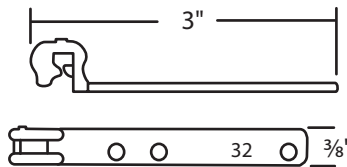

#01-17

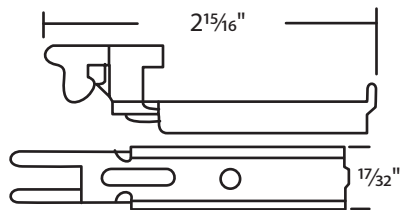

#01-12

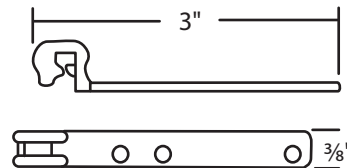

#01-16

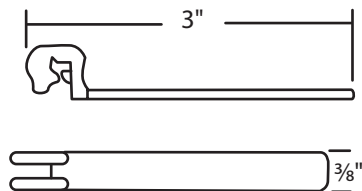

#01-944

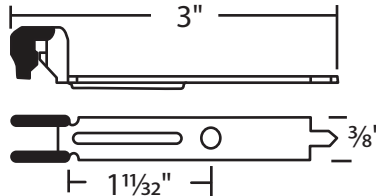

#02-6515

Clip On  
General Aluminum

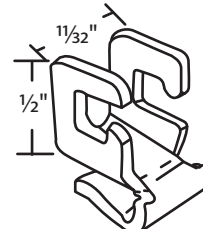

#02-523

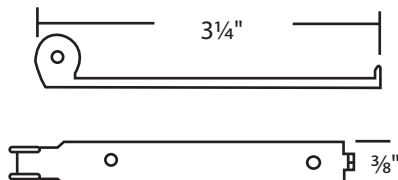

**Brackets**

#02-506

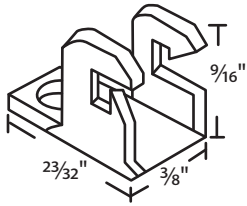

#02-6502  
Kinro/Silverline

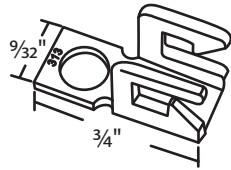

#02-6512

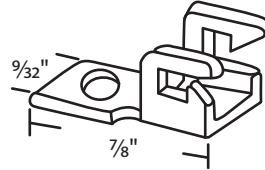

#02-505  
Metal  
#02-505SS  
Stainless Steel

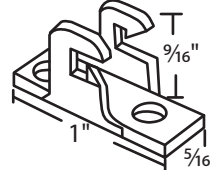

#02-521

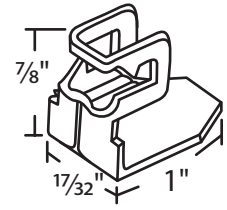

#02-938

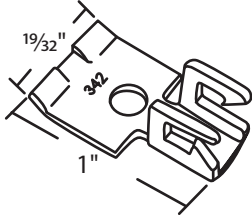

#02-939

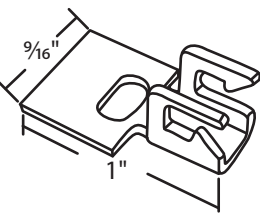

#02-6500

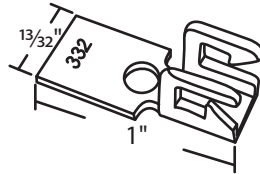

#02-6501

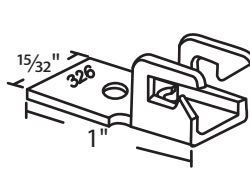

#02-6503

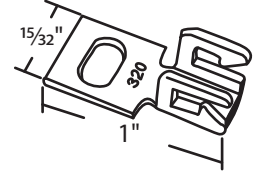

#02-6504

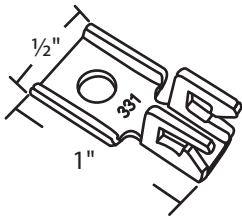

#02-6508

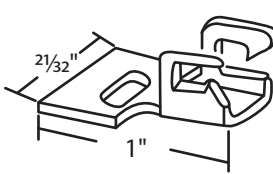

#02-6509

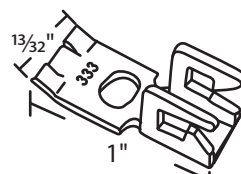

#02-6510

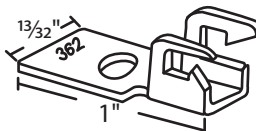

#02-6511

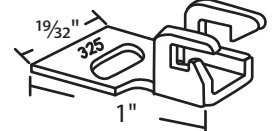

#02-6513

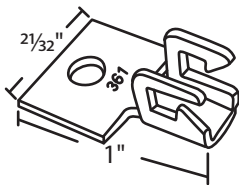

#02-6514

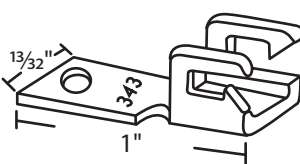

#02-6515

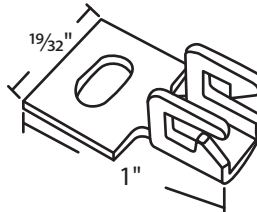

#02-6506

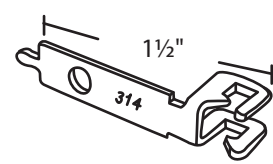

**Pivot Locking Shoes**

#025-10

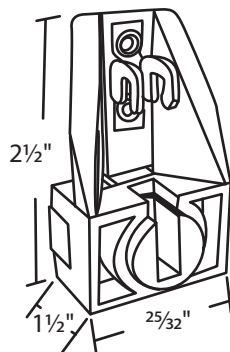

#01-50  
White Cam

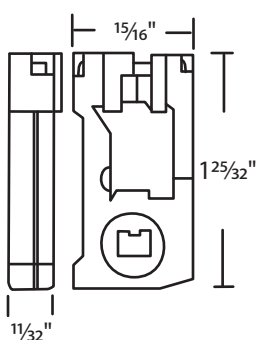

#01-51  
White Cam  
NLA use #01-50

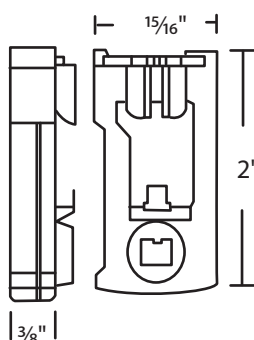

#01-52  
White Cam

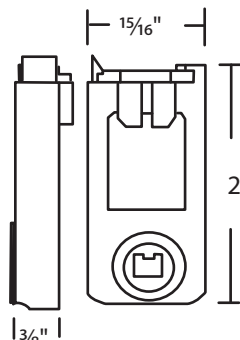

#01-135  
Black Cam

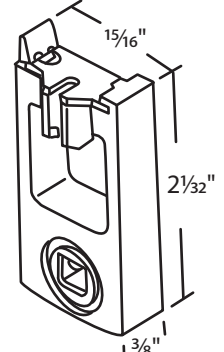

Pivot Locking Shoes



#02-923  
White

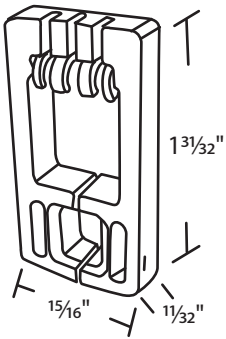

#01-136  
Red Cam

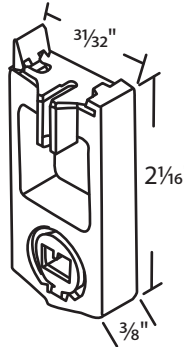

#02-925  
Metal Cam  
Carefree

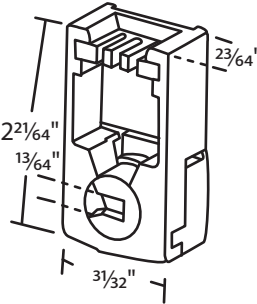

#02-926

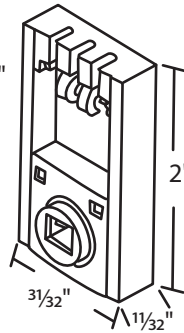

#02-927

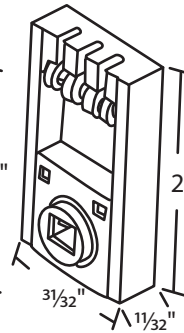

#02-948  
Super Seal

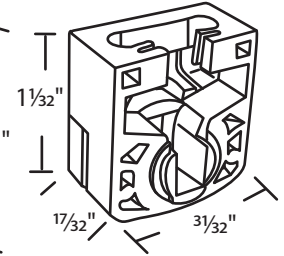

#01-29  
Navy Cam

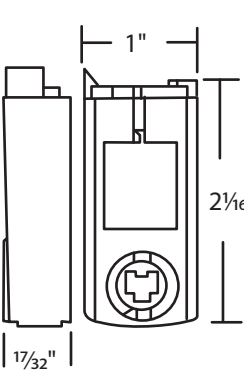

#01-70  
White Cam

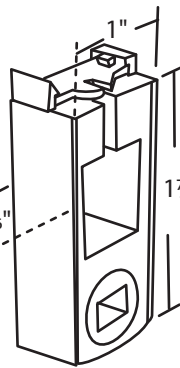

#01-72  
Black Cam\*

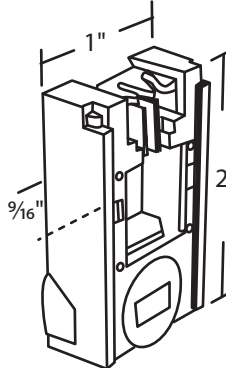

#01-21  
Black Cam

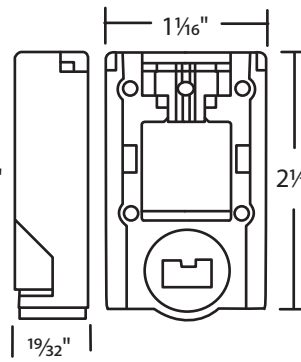

#05-116  
NLA use #05-117

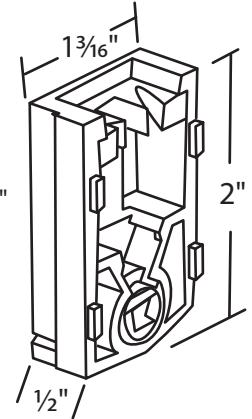

\* Old style NLA has Blue Cam

#05-117

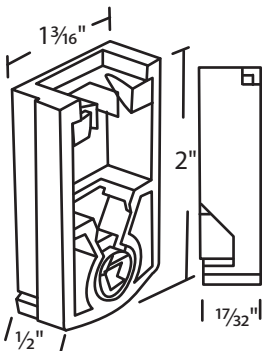

#01-20  
Tan Cam

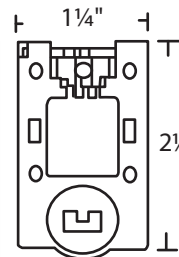

#01-22  
Zinc Metal Cam  
NLA use #01-21

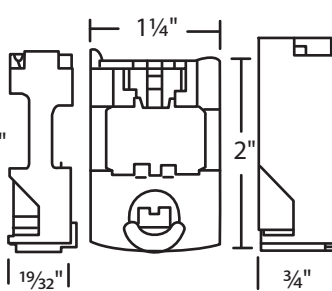

#01-23  
Natural Cam

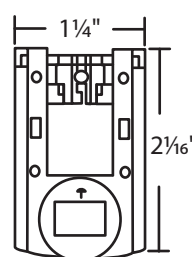

#01-24  
Red Cam

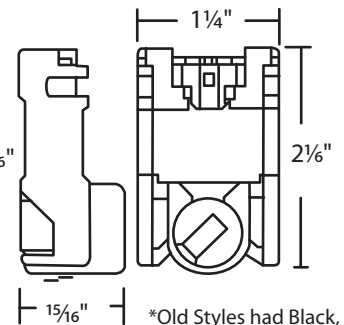

\*Old Styles had Black, White & Zinc Metal

Any questions, call your Account Specialist @ 800.842.0974

Pivot Locking Shoes



**#01-25**  
Use w/ #01-24

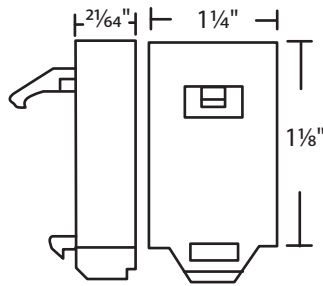

**#01-26**  
Natural Cam

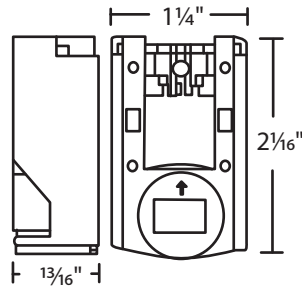

**#01-27**  
White Cam  
NLA use #01-28

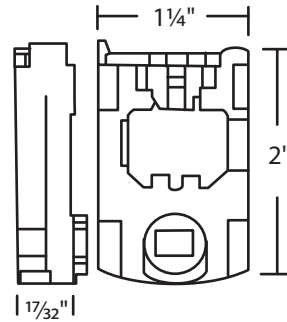

**#01-28**  
Lt. Green Cam

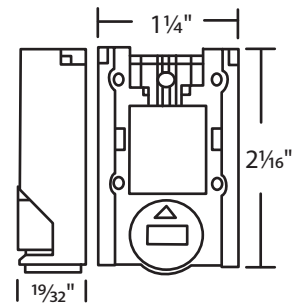

**#01-30**  
Zinc Metal Cam  
NLA use #01-21

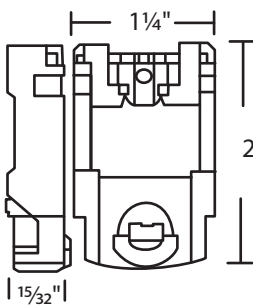

**#01-53**  
Black Cam

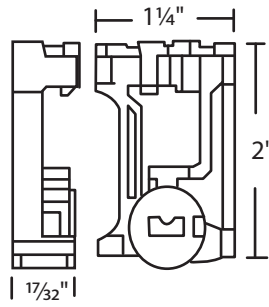

**#01-65**  
Black Cam  
NLA use #01-21

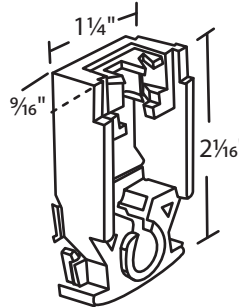

**#01-71**  
White Cam

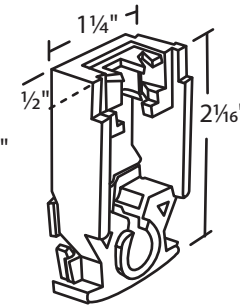

**#01-75**  
Green Cam

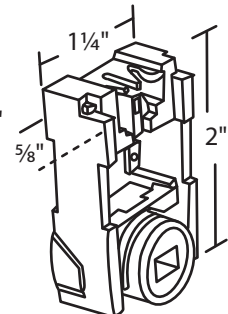

**#01-85**  
White Cam

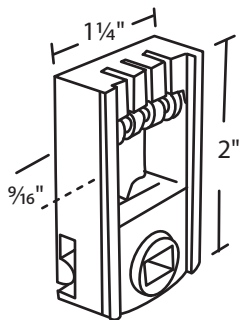

**#01-96**  
White Cam  
NLA use #01-125

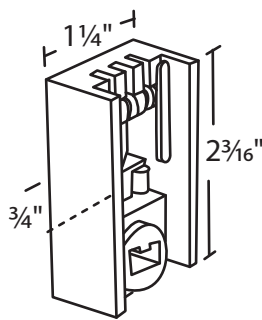

**#01-137**  
Orange Cam

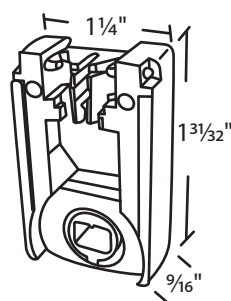

**#01-138**  
Navy Blue Cam

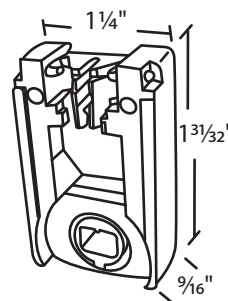

**#01-139**  
Black Cam

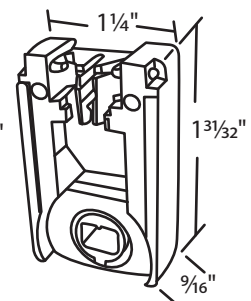

**#02-929**  
Black Enforcer

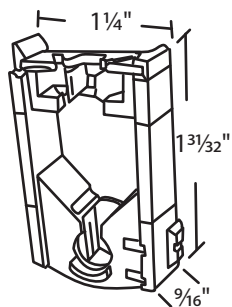

**#02-930**  
Natural Cam  
Orange Locking Pad

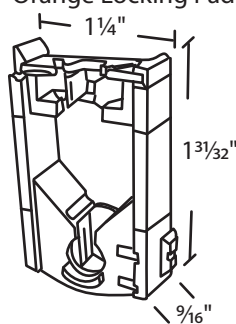

**#02-931**  
Natural Cam  
Navy Blue Locking Pad

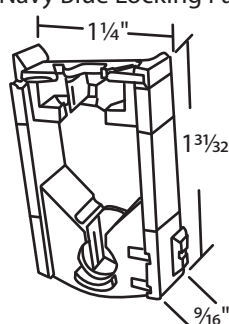

**#02-949**

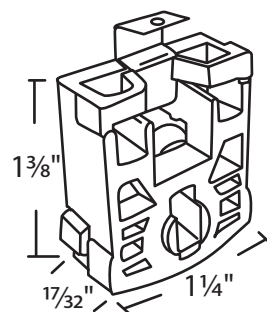

**#02-950**

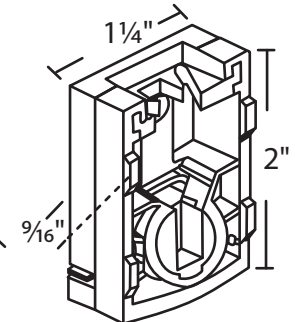

**Pivot Locking Shoes**



**#02-951**

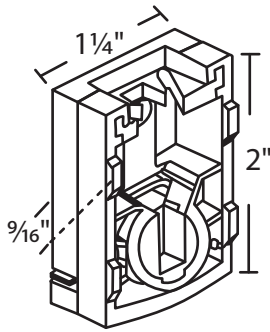

**#05-121**

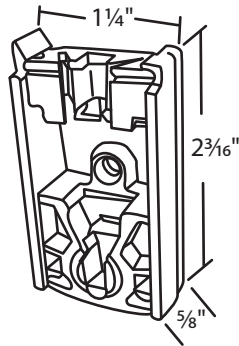

**#012-11**

White Cam

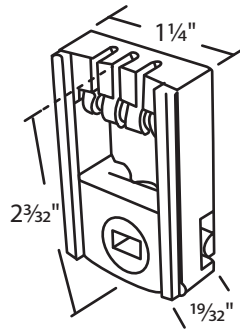

**#072-22**

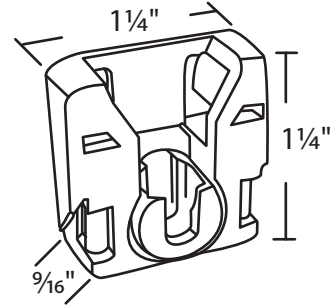

**#072-858B**

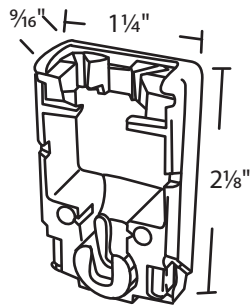

**#01-18**

Blue Cam

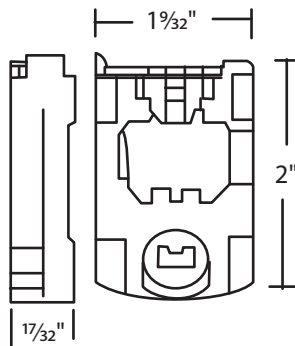

**#01-19 White Cam**

NLA use **#01-18**  
or **#01-20**

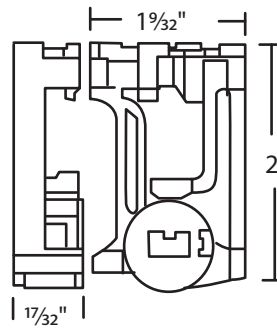

**#05-122**

Republic

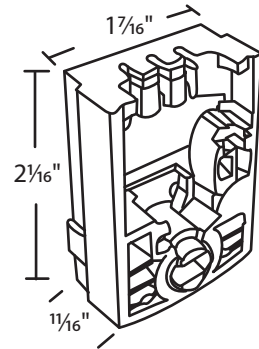

**Locking Shoe Assembly**

**#020-31RH\***  
**#020-32LH**

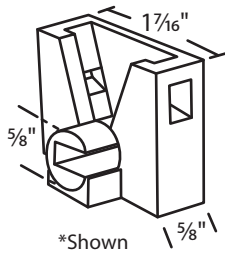

**#020-29**

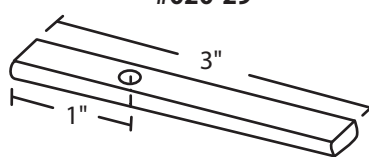

**#020-30**  
Bushing—Metal

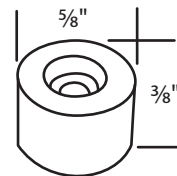

**Brake Rods**

Also for Shoes **#03-12, 13, 14, 21 & 22**

**#05-23**

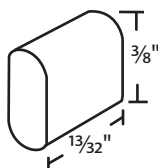

**#05-24**

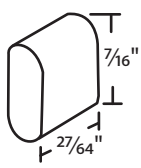

**#05-25**

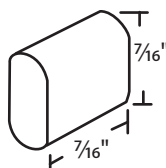

**#017-96**

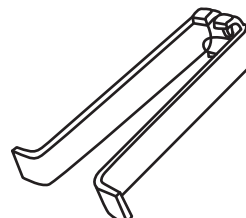

**#020-33**  
Milled Cam

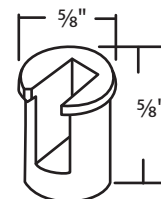

Any questions, call your  
Account Specialist @ **800.842.0974**

**Locking Shoe Assembly**

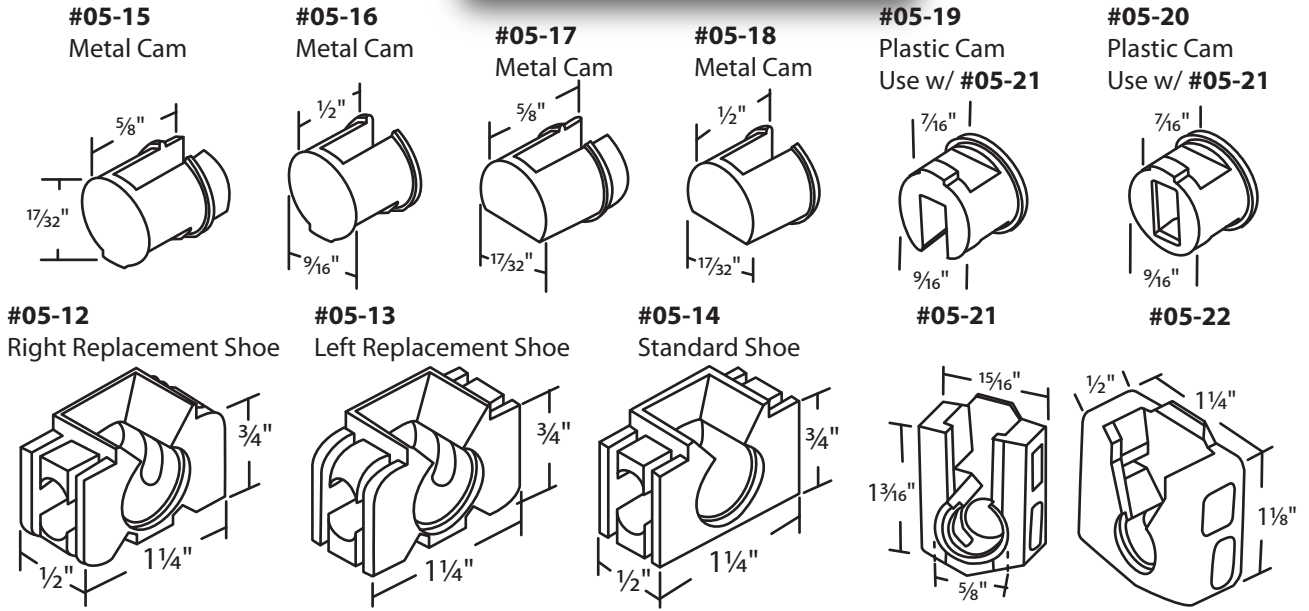

**Fillers/Spacers**

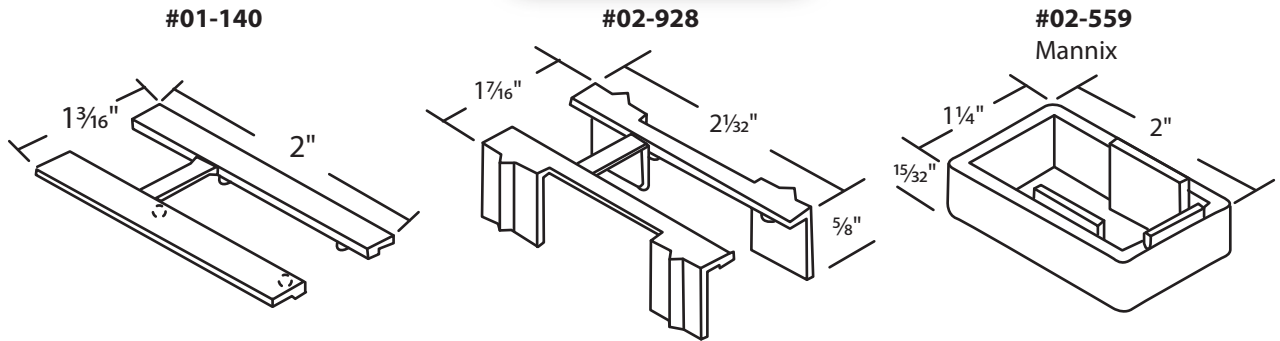

Sorted by length of pivot bar

**Pivot Bars**

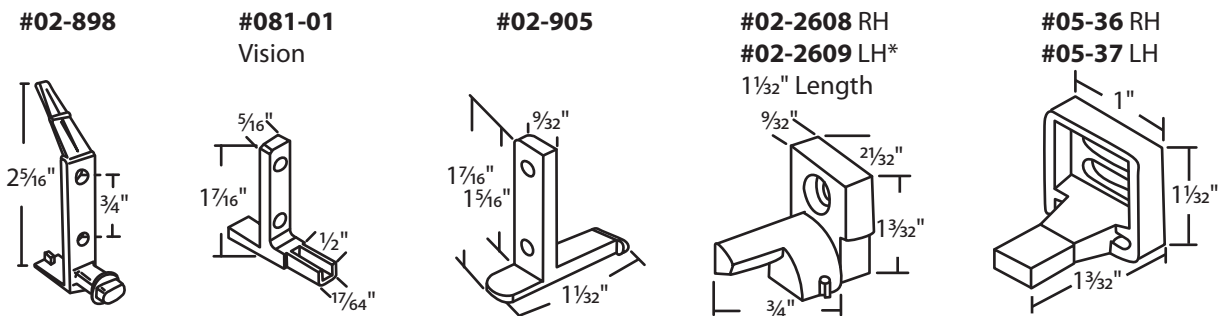
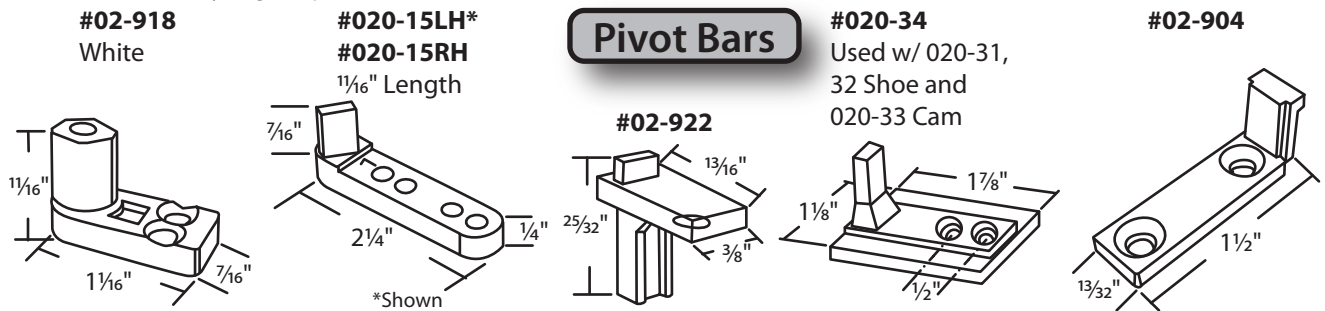

**Pivot Bars**

#02-2600 LH\*  
#02-2601 RH  
1 1/16" Length

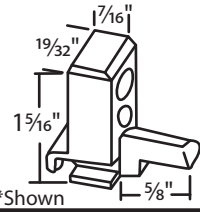

#02-2602

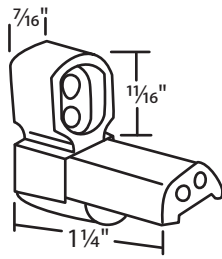

#02-2622  
LH & RH Set

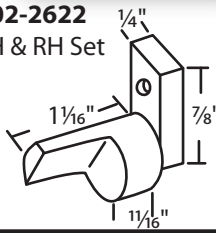

#02-2625 LH  
#02-2626 RH\*

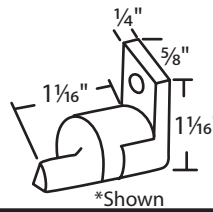

#020-14

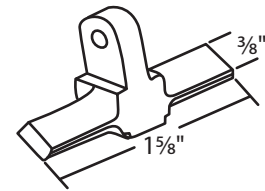

#020-289RH\*  
#020-289LH  
Milco

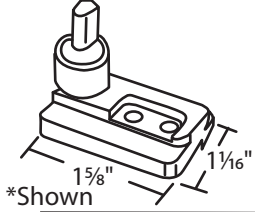

#020-19 Black  
#020-20 White  
RH/LH Set

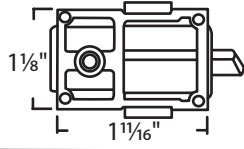

#020-21 Black  
#020-22 White  
RH/LH Set

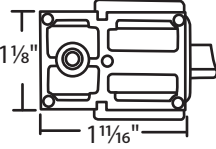

#020-23 Black  
#020-24 White NLA  
RH/LH Set

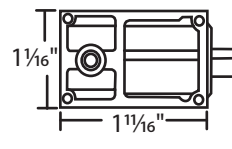

#01-84LH #01-84RH

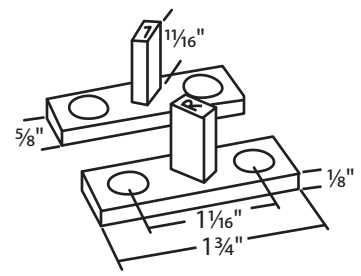

#020-160LH\*  
#020-160RH  
Black

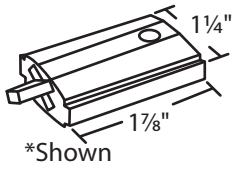

#020-36 RH\*  
#020-37 LH

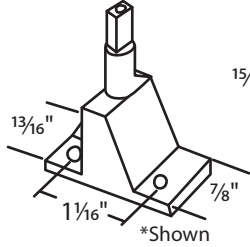

#02-919

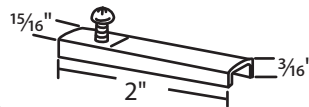

#02-888

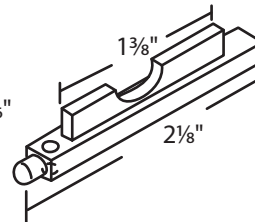

#05-28

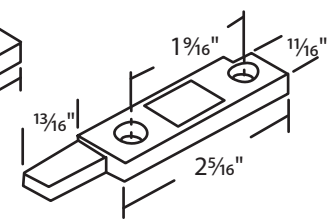

#02-557

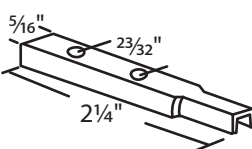

#02-894  
Sold in Sets

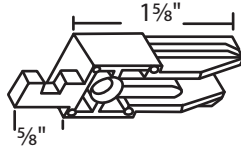

#02-341

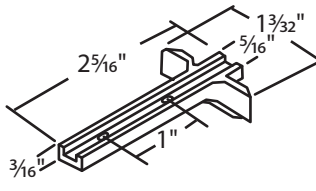

#02-887

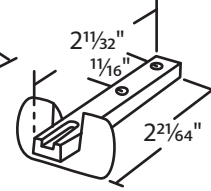

#02-899

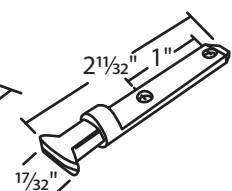

#02-891  
Sold in Set

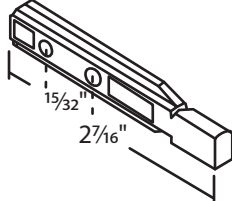

#02-906

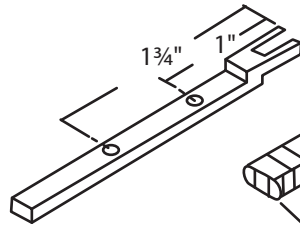

#01-131

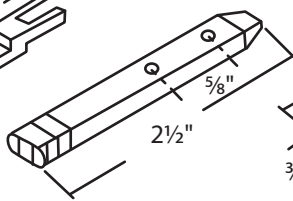

#01-132

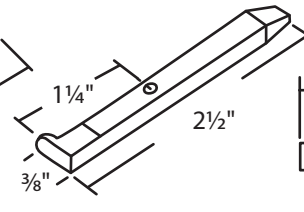

#02-866

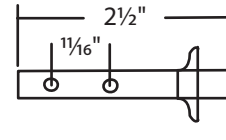

#02-885

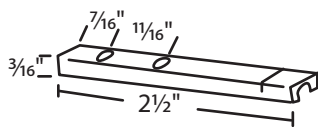

#02-902

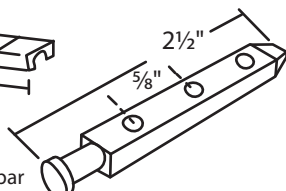

#02-907

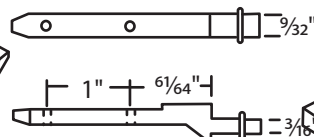

#05-34

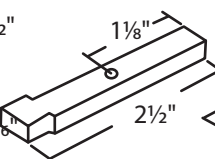

#05-137  
Zinc T-Pivot  
w/ Collar

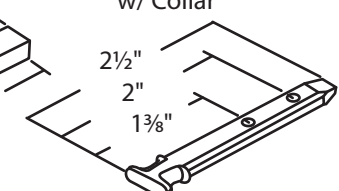

Sorted by length of pivot bar

**Pivot Bars**

Sorted by length of pivot bar

**#05-138**  
Zinc T-Pivot  
w/ Collar

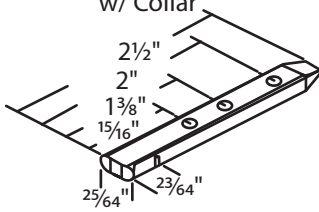

**#05-265A**

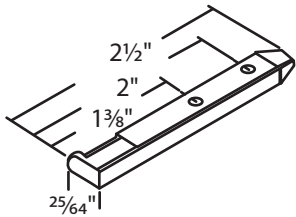

**#05-265K**  
Zinc

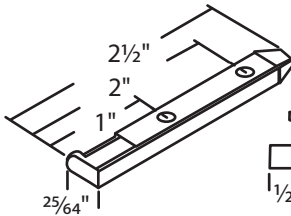

**#05-139**  
Zinc T-Pivot  
w/ Collar

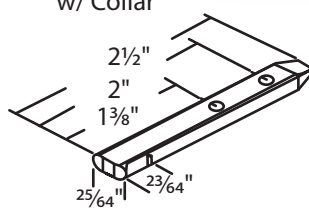

**#05-265B**

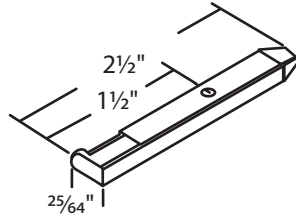

**#05-625**  
Die Cast

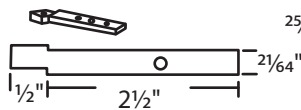

**#05-140**  
Zinc T-Pivot  
w/ Collar

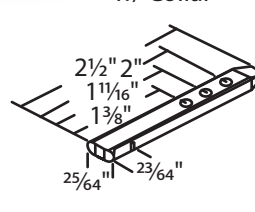

**#05-265D**

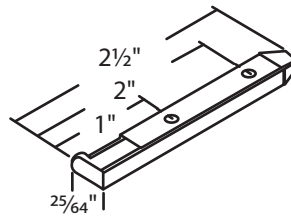

**#05-265**

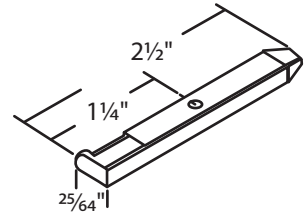

**#05-265H** Zinc  
1/64" Hole Dia. @  
1 7/32" & 1 15/16"

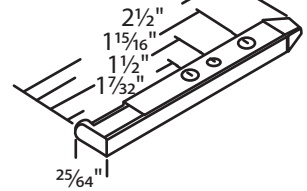

**#02-901**

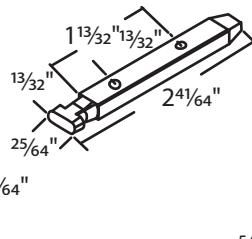

**#02-744**

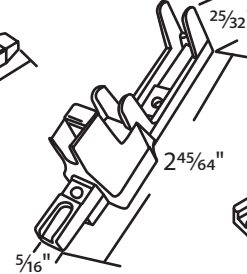

**#02-893**

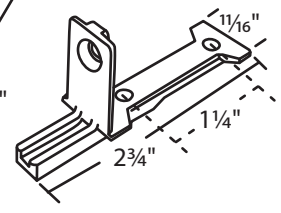

**#02-5500**

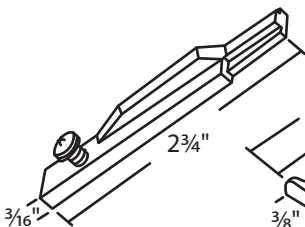

**#01-133**

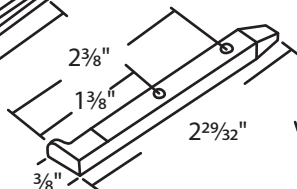

**#05-26 RH\***  
**#05-27 LH**

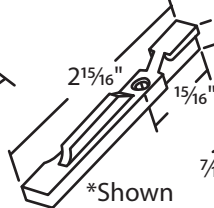

**#05-33**

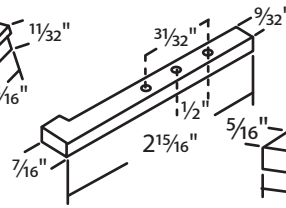

**#01-46**

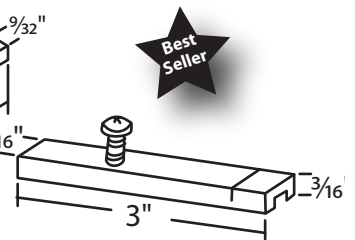

**#01-47**

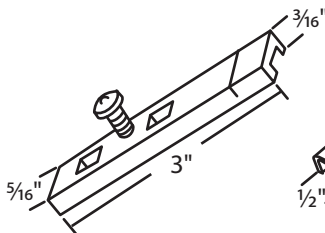

**#01-76**

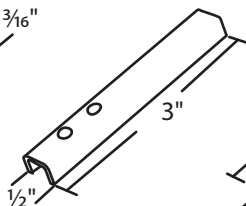

**#02-890**

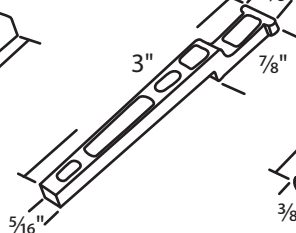

**#02-903**

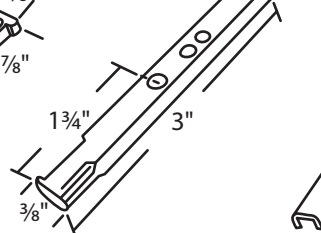

**#05-31**

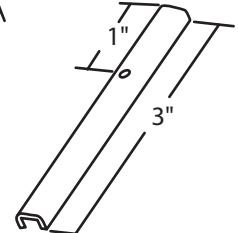

**#05-35**

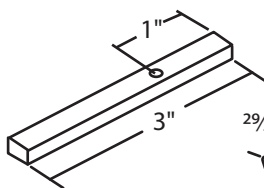

**#05-136**

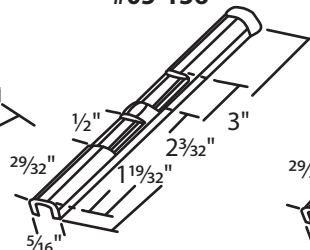

**#01-45**

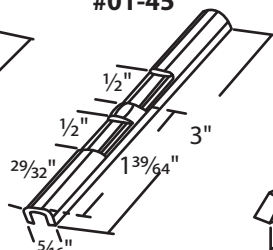

**#020-10**

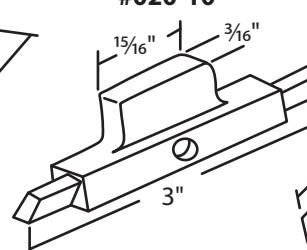

**#020-29**

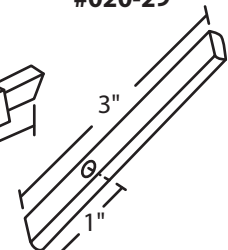

Sorted by length of pivot bar

Pivot Bars

#020-40  
New Style

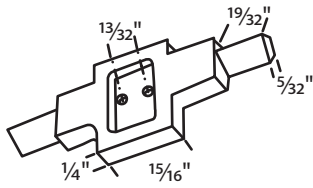

#020-40  
Old Style  
NLA use  
New Style

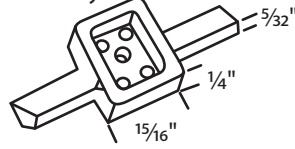

#05-32

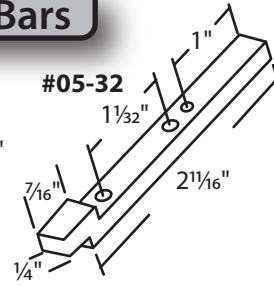

#02-886

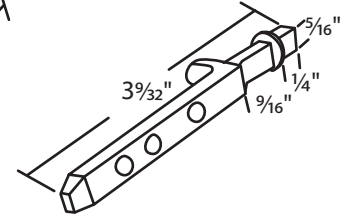

#020-12  
Sold in Sets

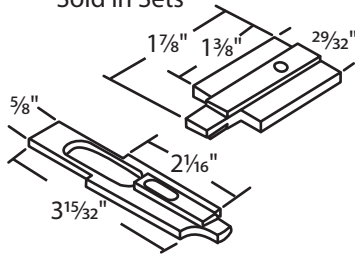

#02-889  
3 9/16" Length

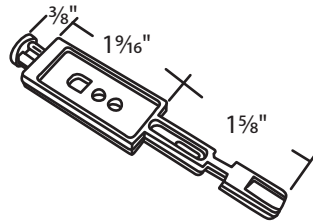

#020-13

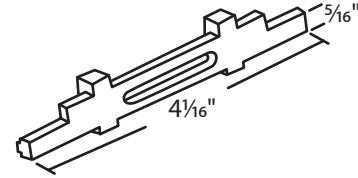

#05-29

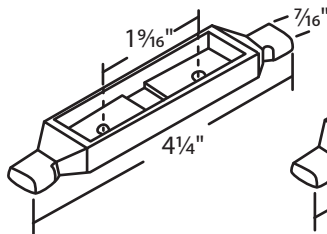

#05-30

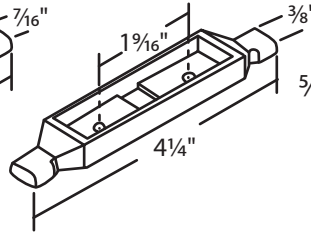

#01-46

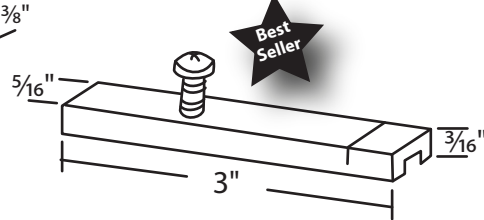

Thank You  
for Using Our Services!

Your Satisfaction  
is Important to Us!

Any questions, call your  
Account Specialist @ 800.842.0974