

Latches, Sash Cams

#010-16 RH Shown
#010-17 LH

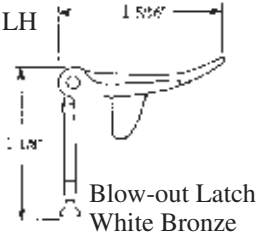

Blow-out Latch
White Bronze

#02-615 RH
Pairs Only
#02-616 LH
Black

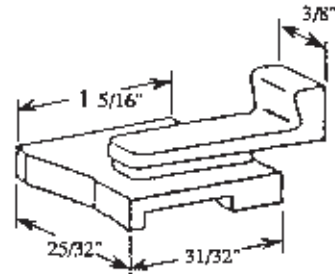

#020-63
Die Cast

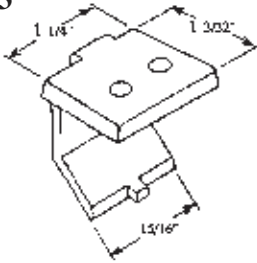

#025-33

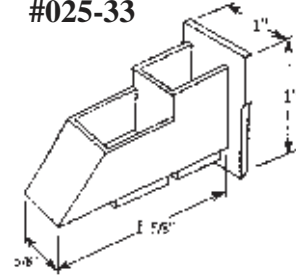

#025-31

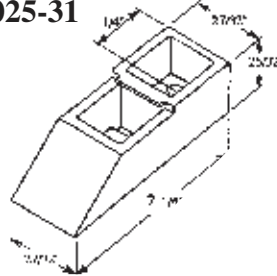

#025-32

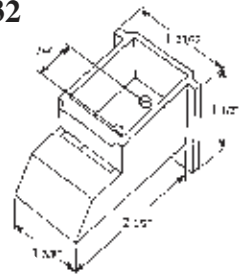

#02-104
White

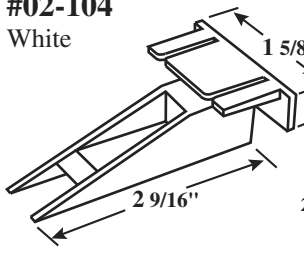

#02-110
White

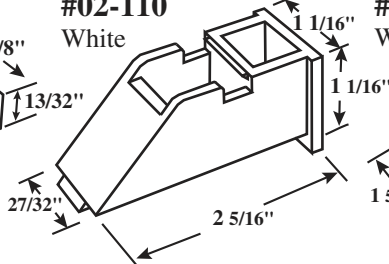

#02-124
White

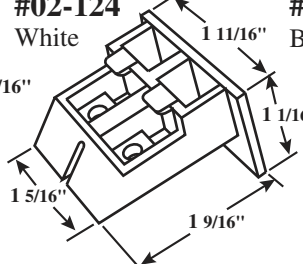

#02-157 LH/RH
Black

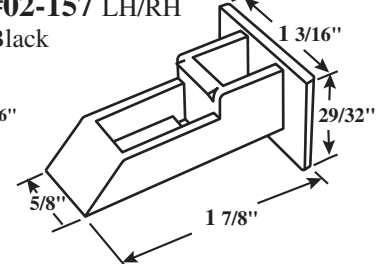

#02-167
White

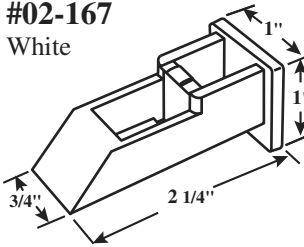

#02-179
White

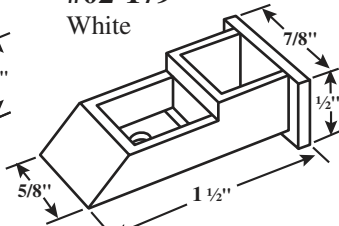

#02-190
White

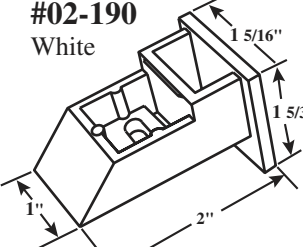

#02-206
White

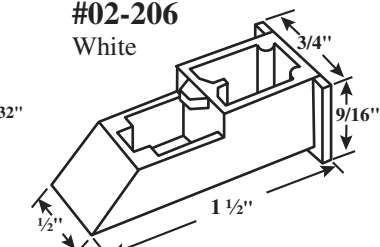

#02-269
White

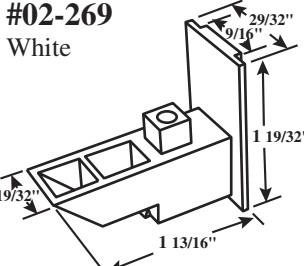

#02-9863
Black

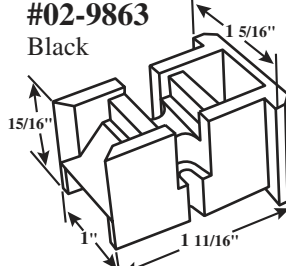

#02-186
Black

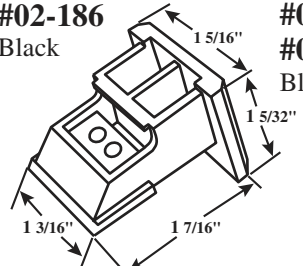

#02-192LH Shown
#02-192RH
Black

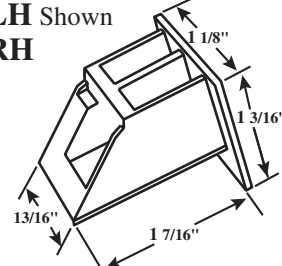

#02-211
White

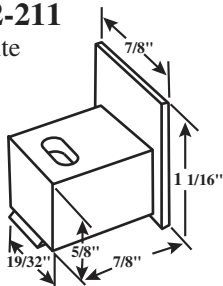

#02-5464

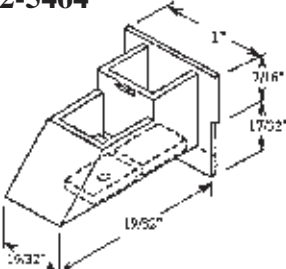

#02-0582

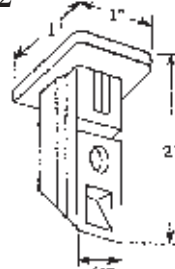

#02-5420

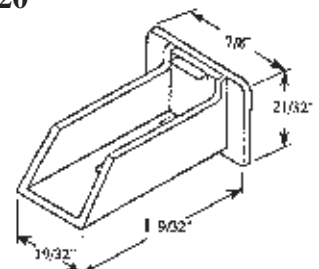

Sash Cams

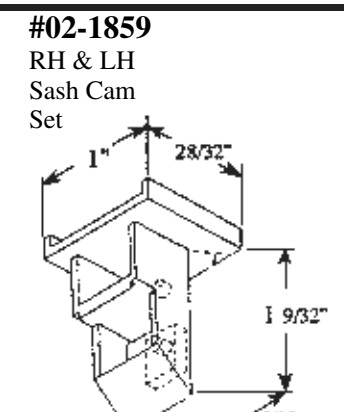
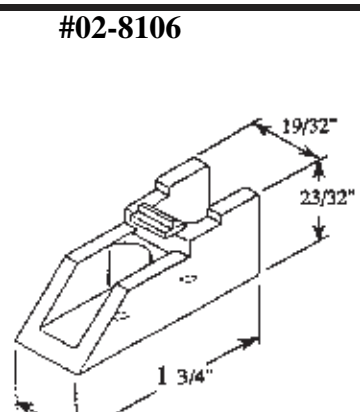
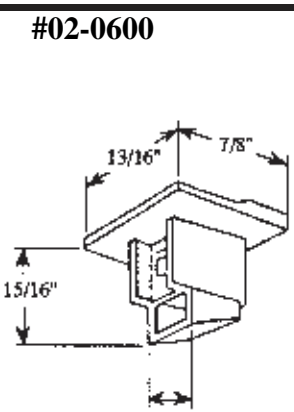
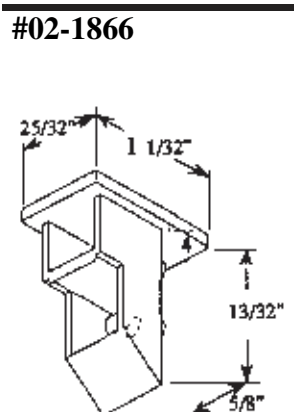
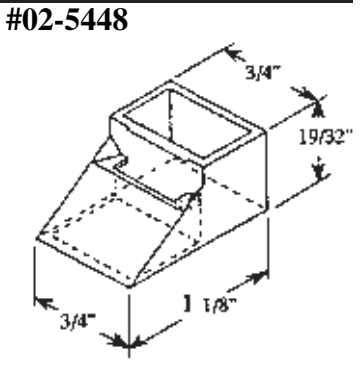
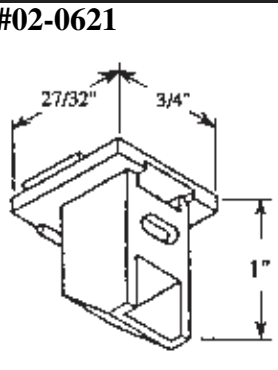
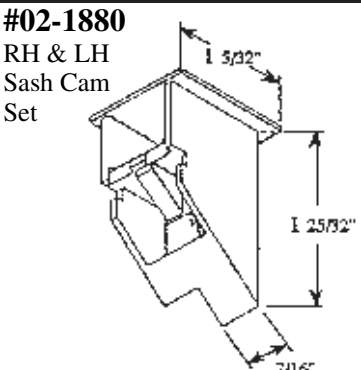
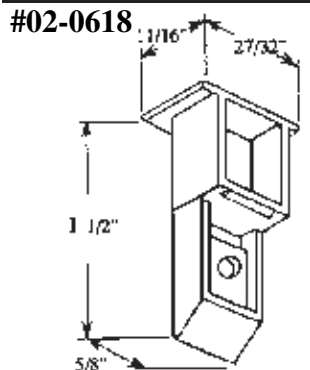
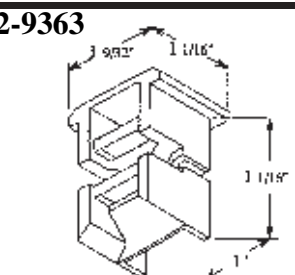
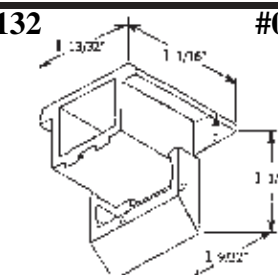
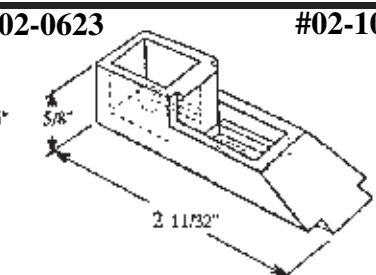
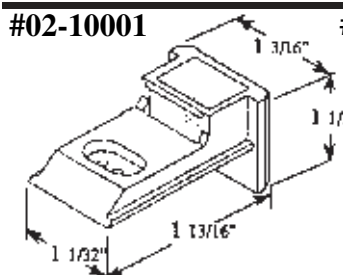
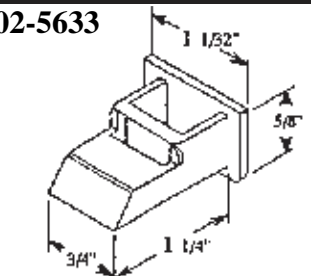
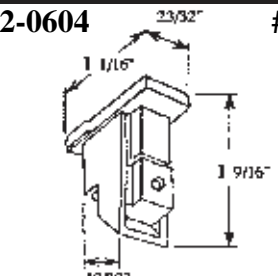
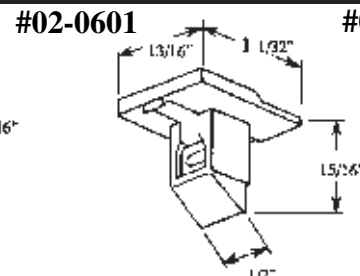
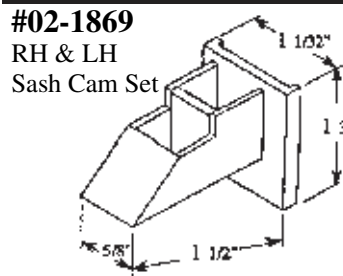
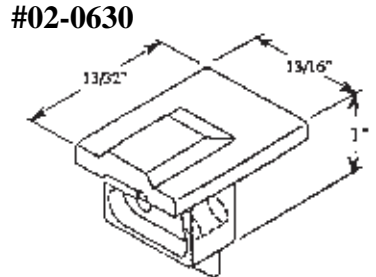
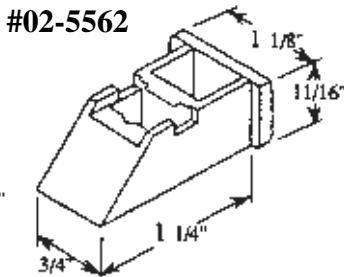
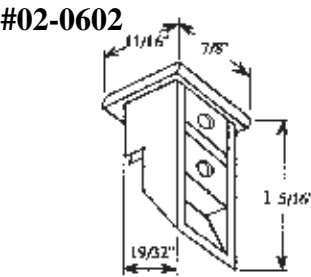
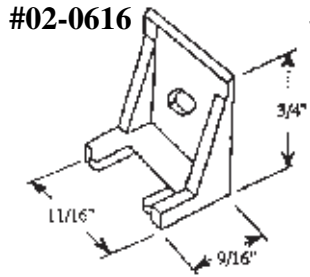

Sash Cams

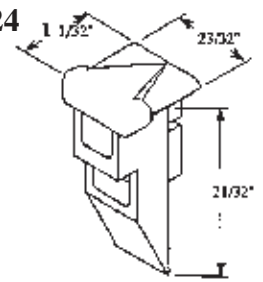
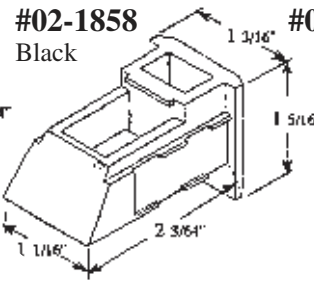
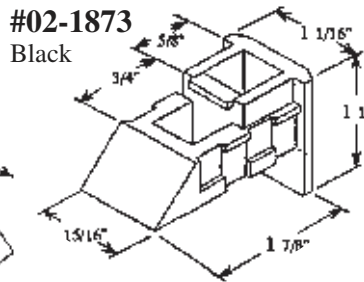
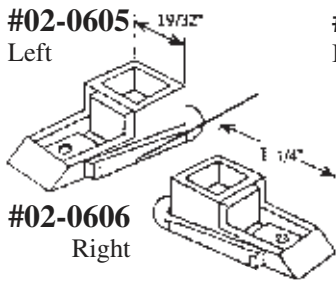

#020-58
Specify:
Black / White

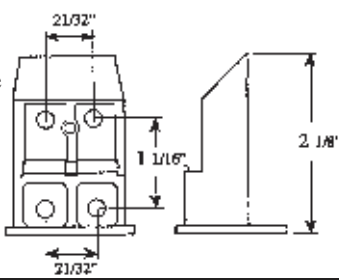

#02-0607
Metal

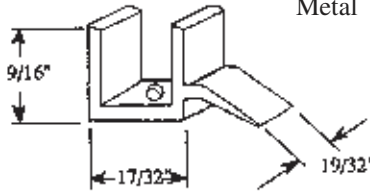

#02-0611
Metal

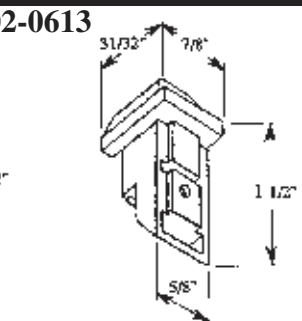
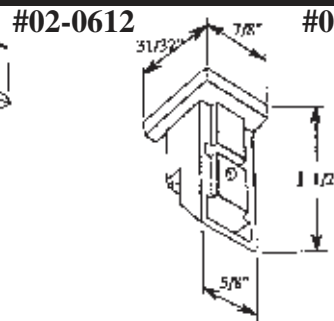
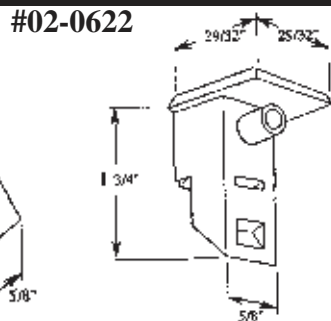
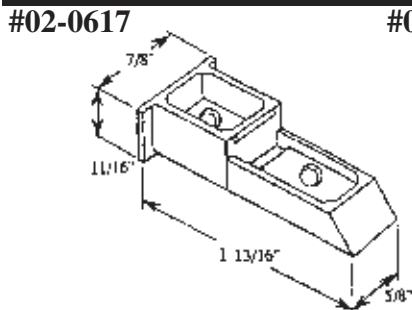
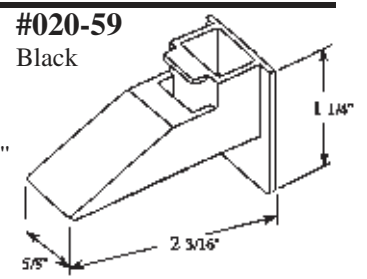
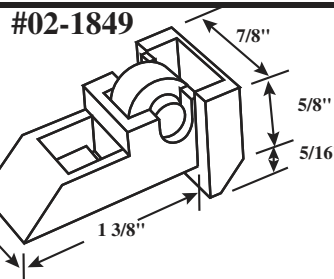
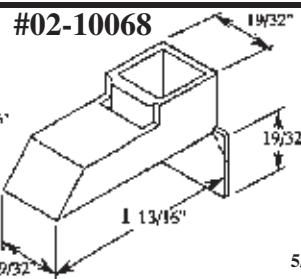
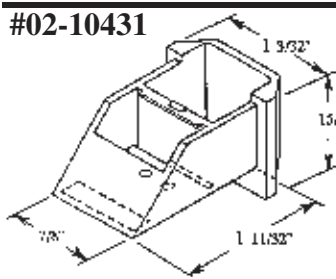
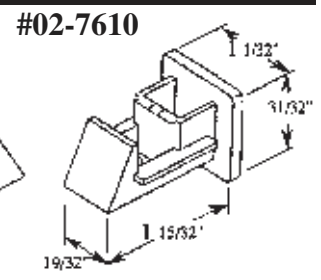
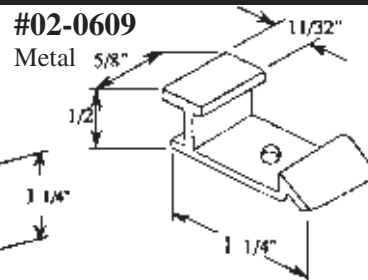
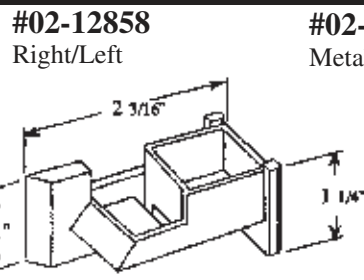
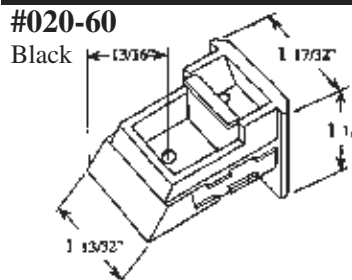
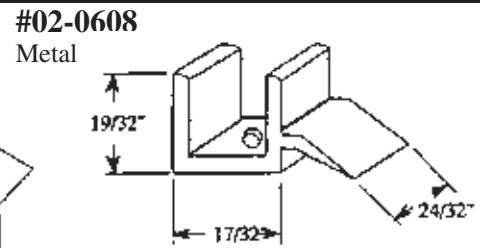
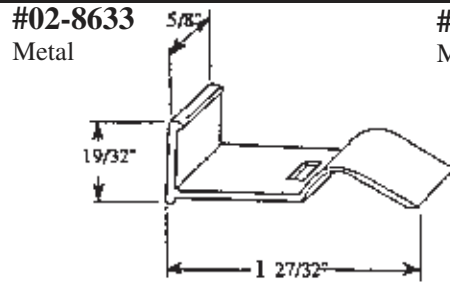
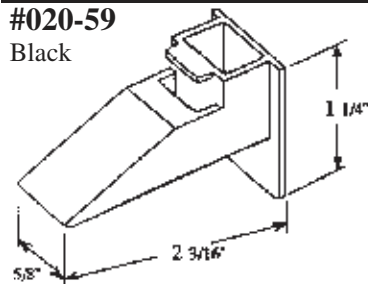
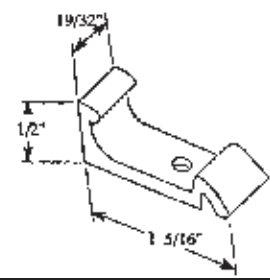

Sash Cams, Top Guides

#02-5333

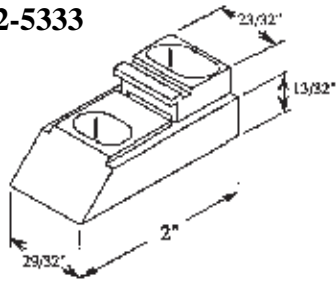

#02-1792

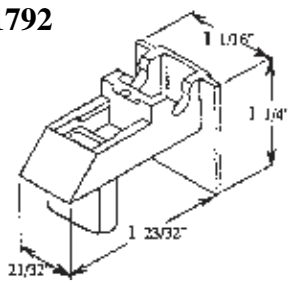

#02-0603

Also available with 4 screw holes #01-54

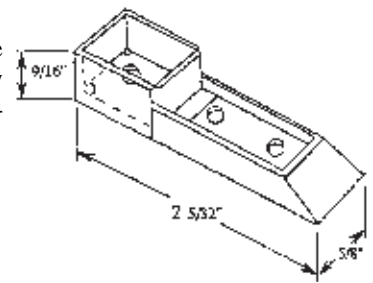

#02-2631

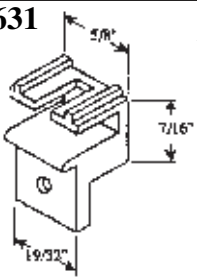

#01-42 Winged

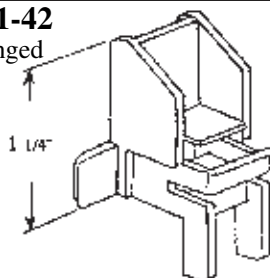

#01-43

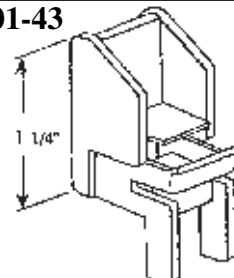

#02-11760

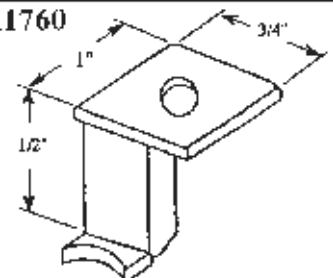

#02-620

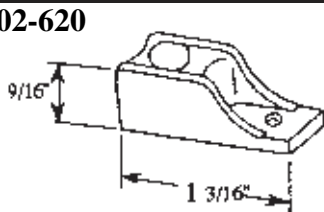

#02-634

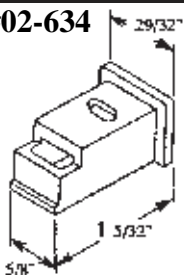

#02-633

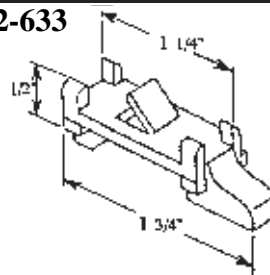

#02-603

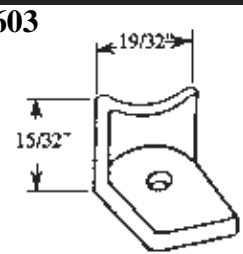

#02-614

Actual Size



#02-0513

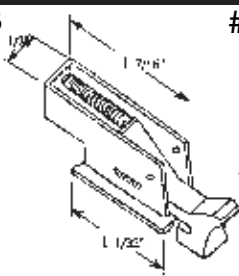

#02-0594

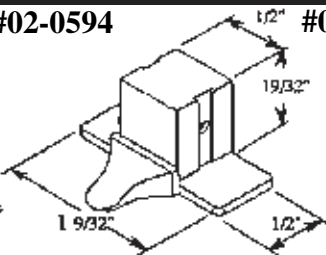

#02-0588

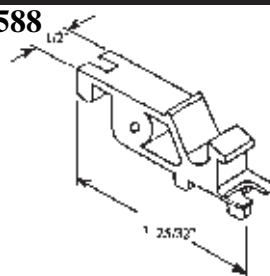

#02-0595

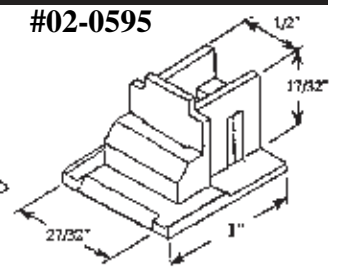

#02-6763

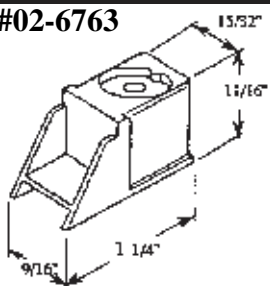

#02-0563

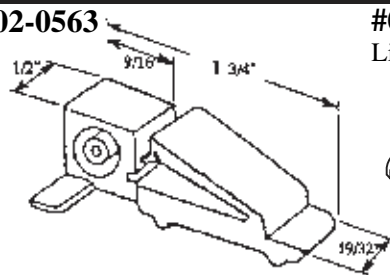

#020-155

Litex

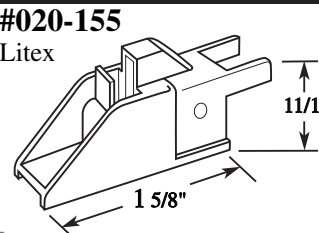

#02-0575

Assembly

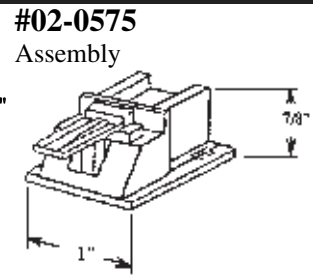

#02-0586

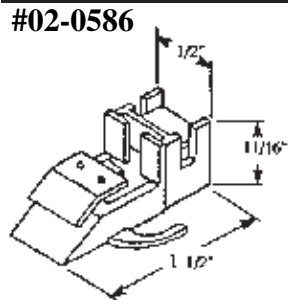

#02-0511

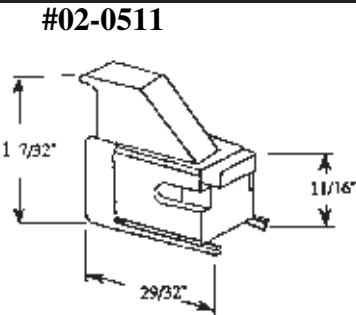

#02-0578

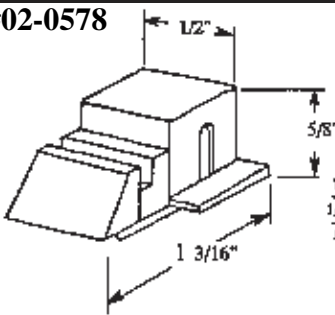

#02-0585

