

Projection Window: Pressure Shoes

#09-59 RH Shown
#09-58 LH
 Black
#09-59RH
#09-58LH
 White

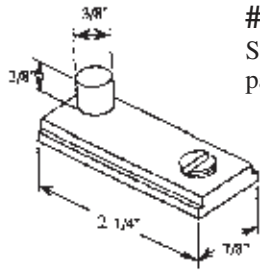

#09-123
 Sold in pairs only.

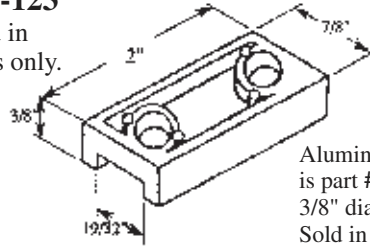

Aluminum Pin
 is part **#09-123P**
 3/8" dia. x 1 7/8" long.
 Sold in pairs only.

#09-86 RH Shown
#09-85 LH

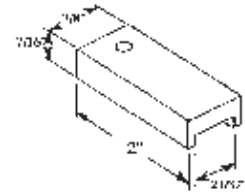

#09-122

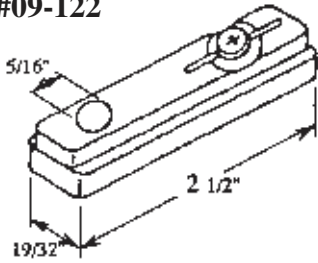

#06-10
 Sold in pairs only.

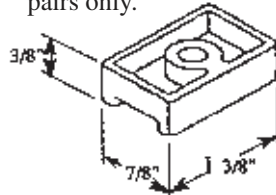

#06-11

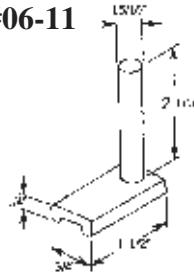

#06-12



#06-13
 RH/LH
 White
 Sold in pairs only.

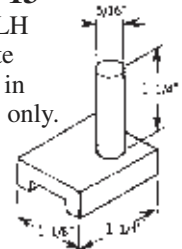

#06-14

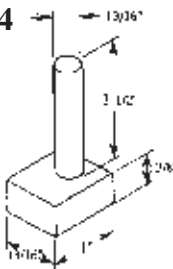

#06-15
 White
 Sold in pairs only.

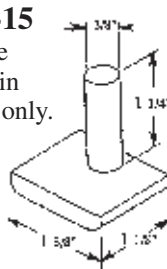

#06-16

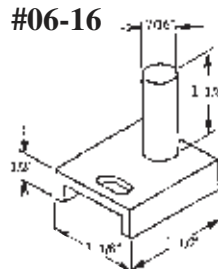

#06-17
 RH/LH
 Sold in pairs only.

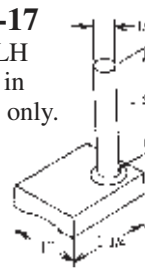

#06-18
 RH/LH
 Sold in pairs only.

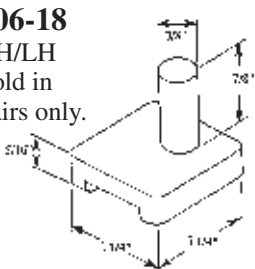

#06-19

RH/LH
 Sold in pairs only.

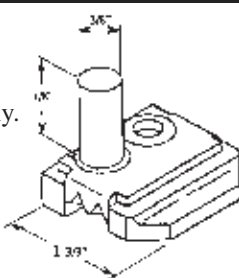

#06-20

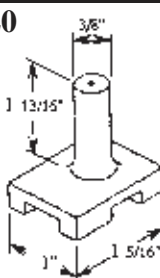

#06-21
 Sold in pairs only.

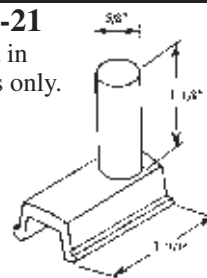

#06-22

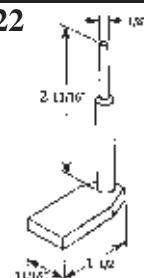

#09-55

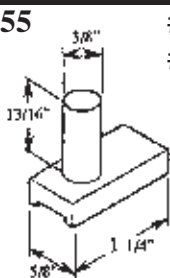

#09-66 RH Shown
#09-65 LH

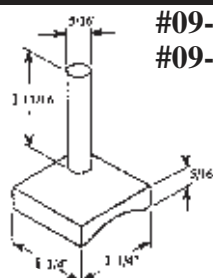

#09-63 RH Shown
#09-62 LH

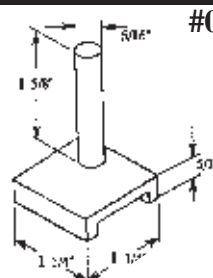

#09-69

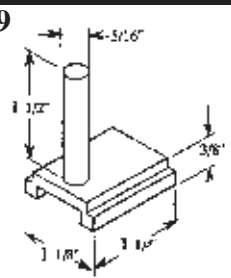

#09-105

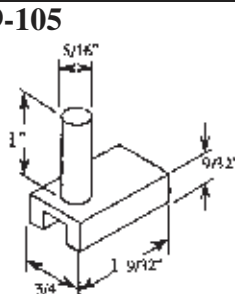

#09-68

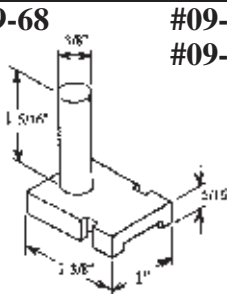

#09-93 RH Shown
#09-92 LH

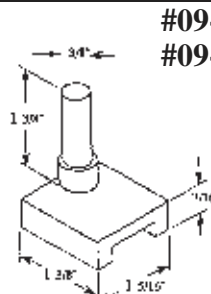

#09-88 RH Shown
#09-87 LH

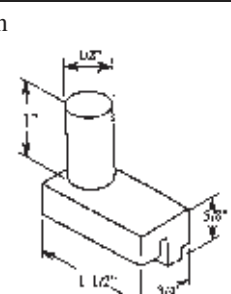

Projection Window: Pressure Shoes

#09-84 RH Shown
#09-83 LH

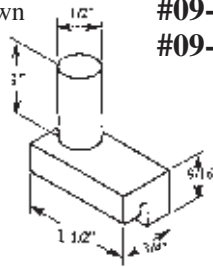

#09-121 RH Shown
#09-120 LH

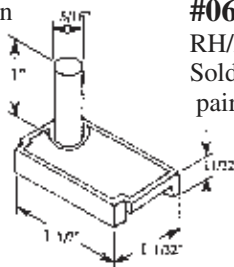

#06-23
RH/LH
Sold in pairs only.

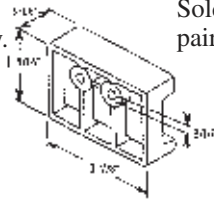

#06-28
RH/LH
Sold in pairs only.

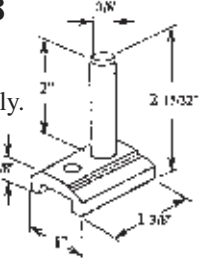

#06-31

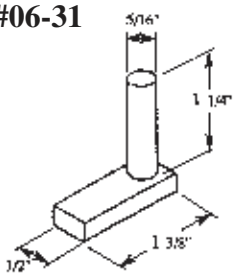

#06-24

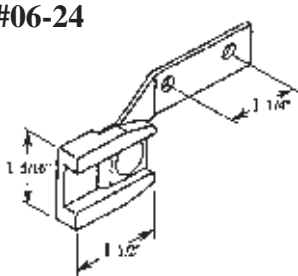

#06-29
RH/LH
Sold in pairs only.

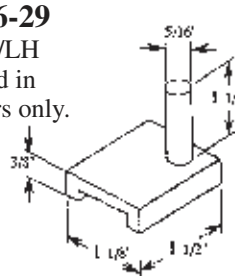

#06-32

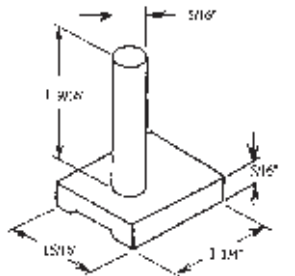

#06-25
RH/LH
Sold in pairs only.

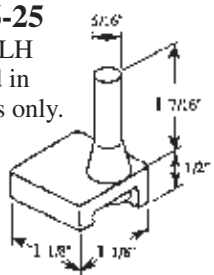

#06-30

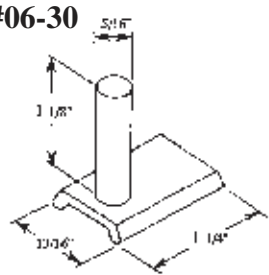

#06-33

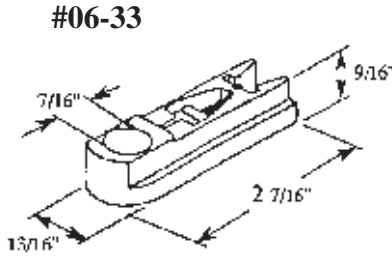

#06-26
RH/LH
Sold in pairs only.

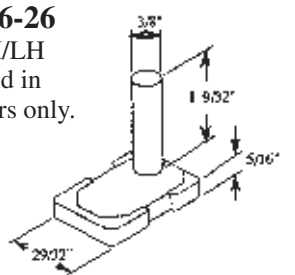

#06-34
RH/LH
Sold in pairs only.

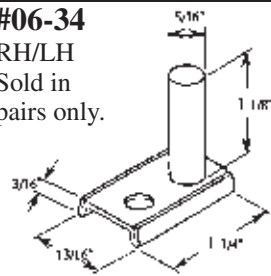

#09-13543

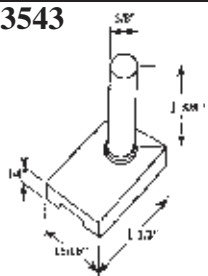

#09-109 RH Shown
#09-108 LH

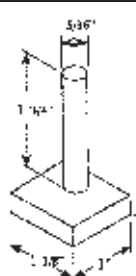

#09-117

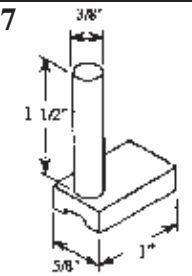

#017-16

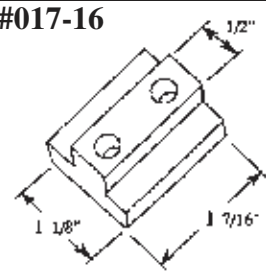

#09-81
RH/LH
Sold in pairs only.

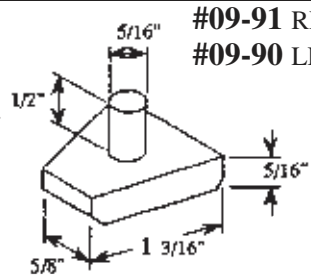

#09-91 RH Shown
#09-90 LH

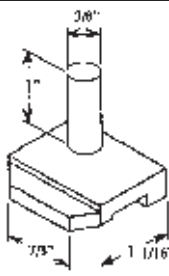

#09-8579

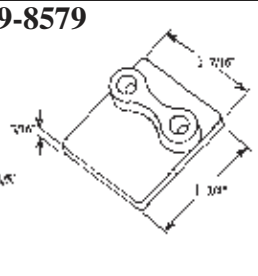

#09-111 RH Shown
#09-110 LH

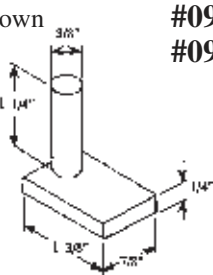

#09-99 RH Shown
#09-98 LH

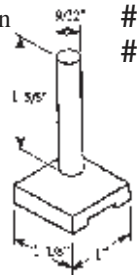

#09-57 RH Shown
#09-56 LH

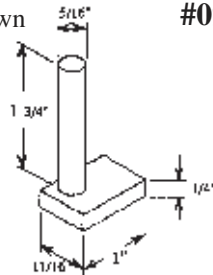

#09-118

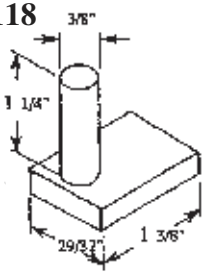

Projection Window: Pressure Shoes, Housings, Pins and Springs

Projection Window: Pressure Shoes, Housings, Pins and Springs

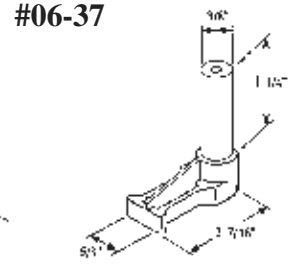
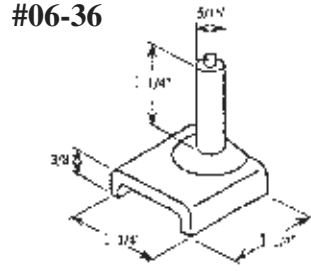
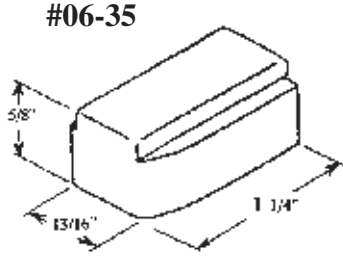
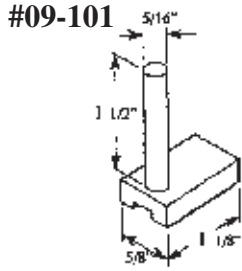

Please send sample.
Many styles available.

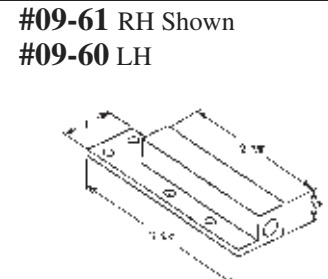
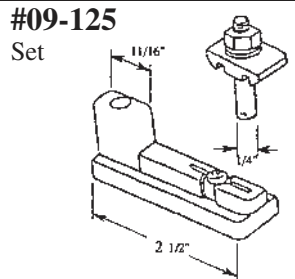
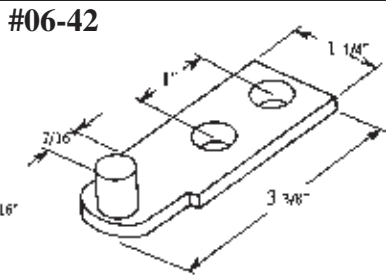
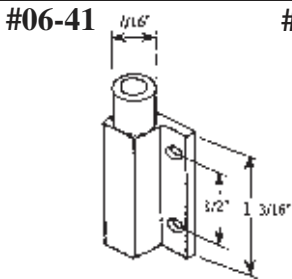
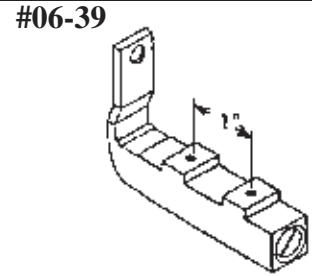
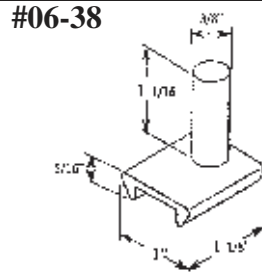
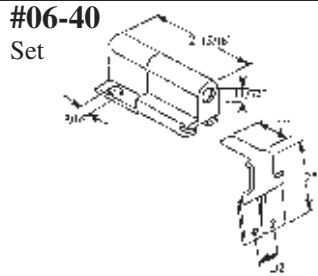
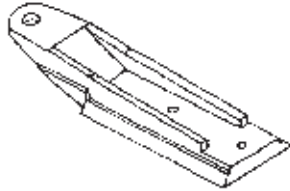

#09-80 RH Shown
#09-79 LH
Sold in pairs only.

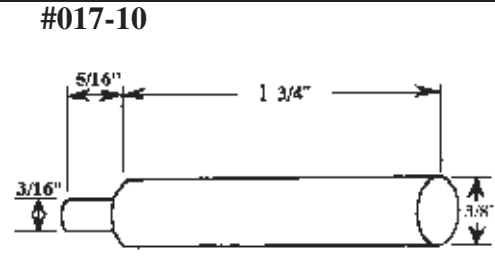
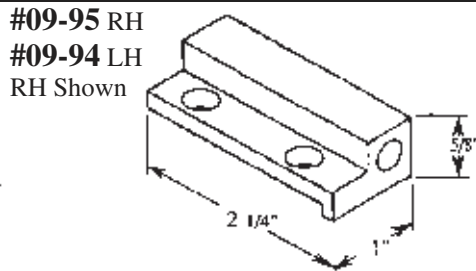
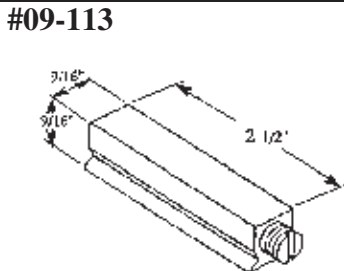
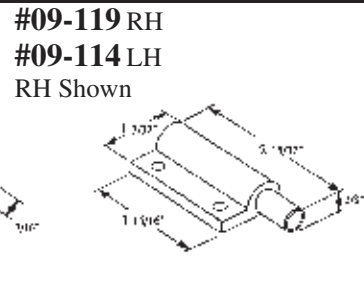
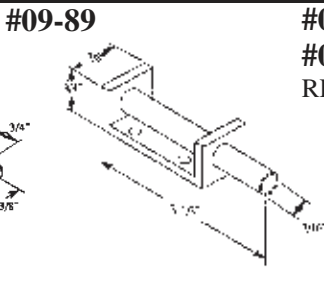
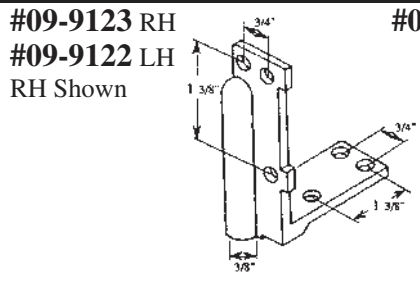
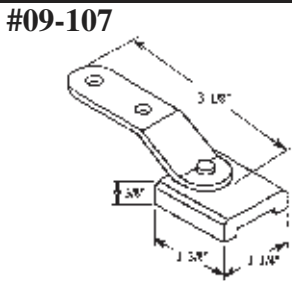
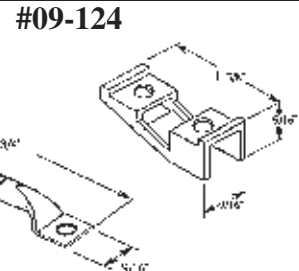
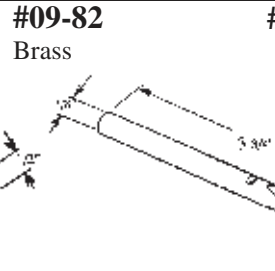
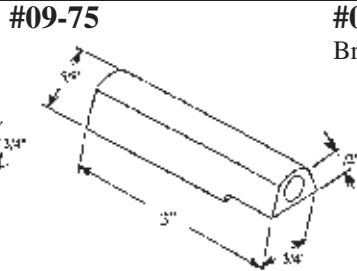
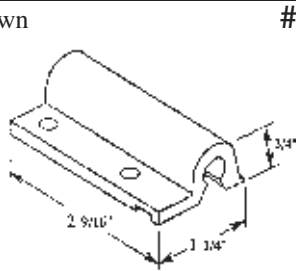

Projection Window: Pressure Shoes, Housings, Pins and Springs

#017-11
Specify Length

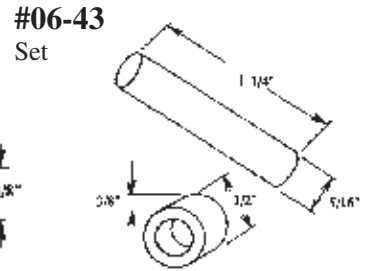
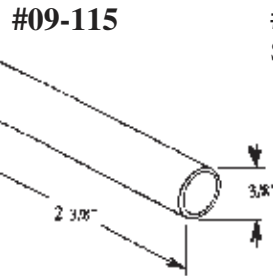
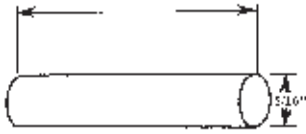

#017-12
Specify Length

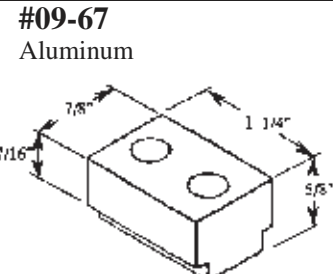
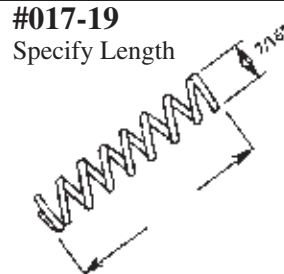
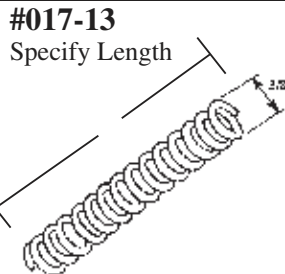
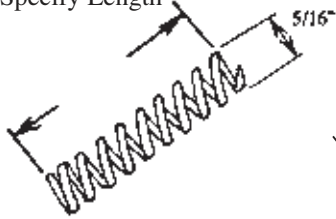

#09-76
Sold only in pairs.

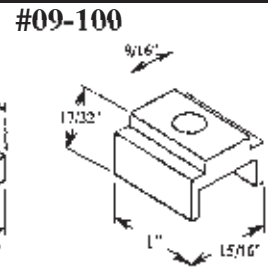
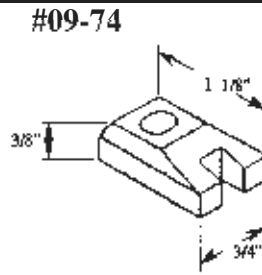
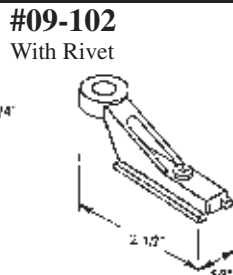
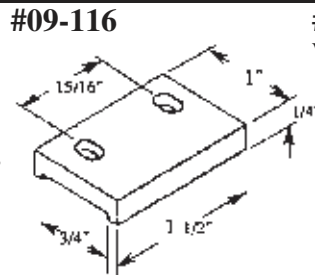
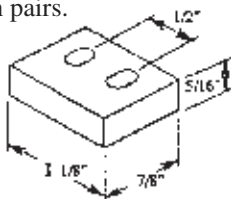

#09-850
Aluminum

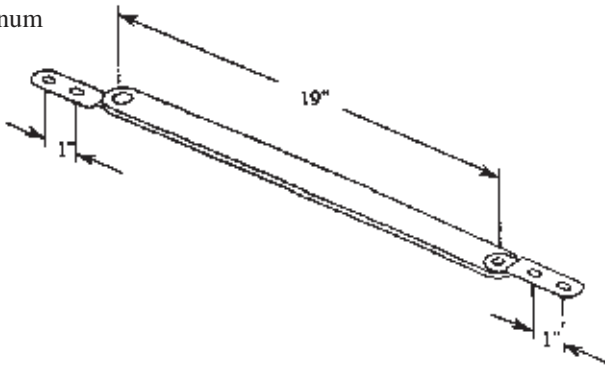

#09-851
Aluminum

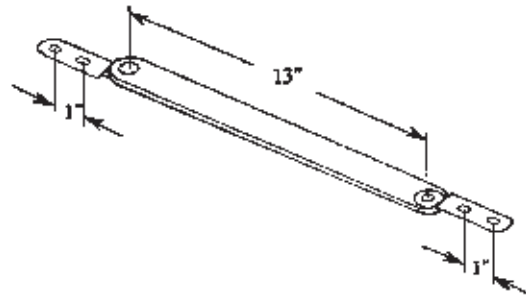

#09-852
Aluminum with Nylon Bushings

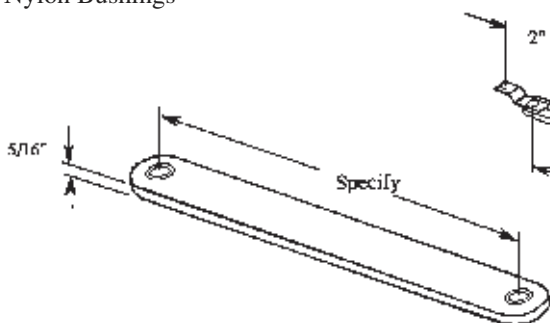

#09-855
Aluminum

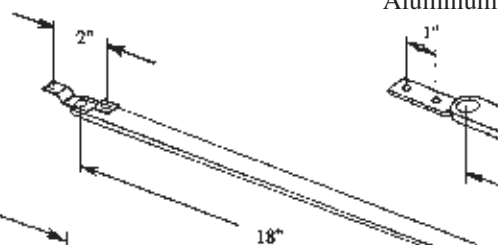

#09-856 RH Shown
#09-857 LH
Aluminum

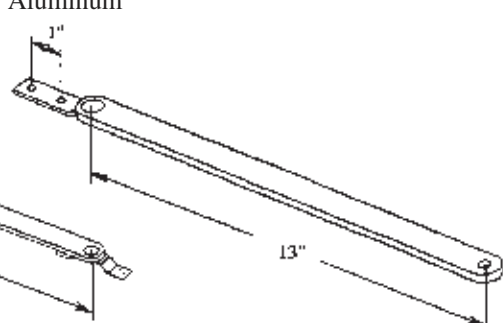

Four Bar Hinges, Friction Adjusters, Support Arms

Series #014-12
Standard Duty

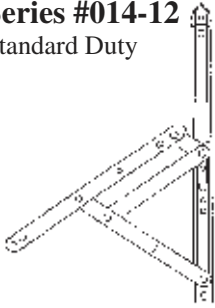

Series #014-13
Aluminum Hinge



Series #014-14
Heavy Duty Hinge
Available in
Stainless Steel, Aluminum,
and Steel

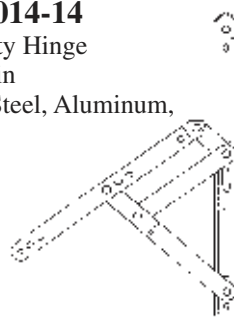

Series #014-15
Egress Hinge for Maximum Sash Opening

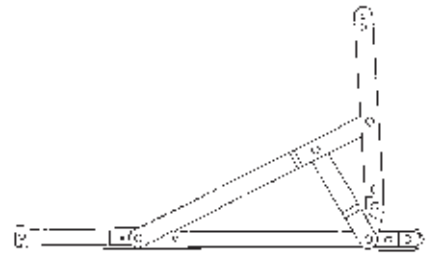

Friction Adjusters

(Typical Application)
Prevents Sash Blow-in

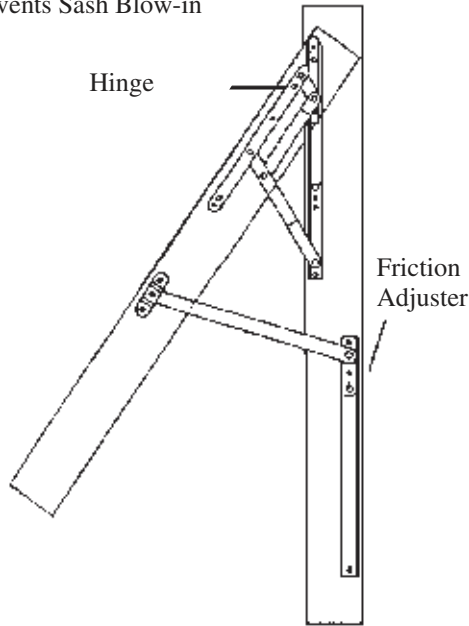

#014-16

Heavy Duty
Stainless Steel

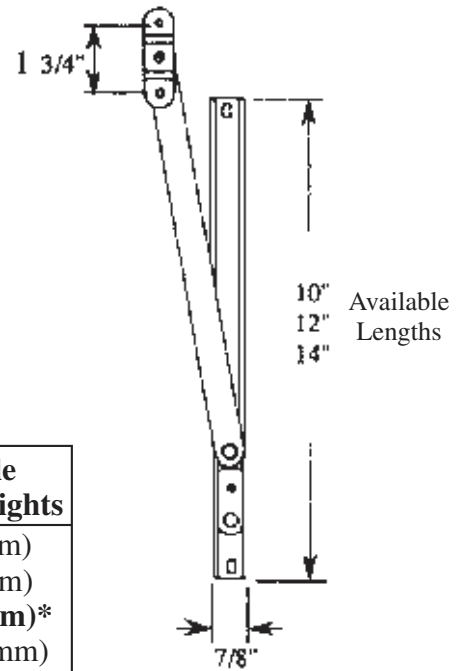

Available Bracket Heights

- .110 (2.8mm)
 - .180 (4.6mm)
 - .235 (6.0mm)***
 - .422 (10.7mm)
- *Standard

Support Arms

(Typical Application)
Prevents Sash Blow-in

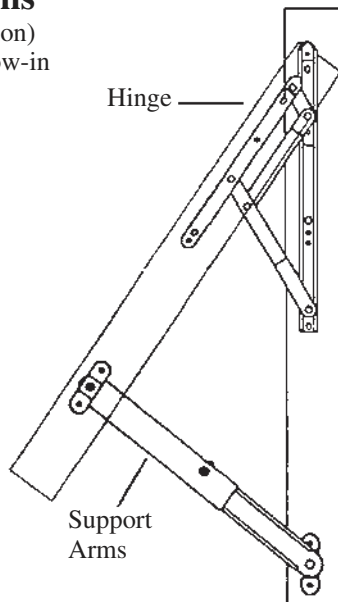

#014-17

Also Available
without Brackets

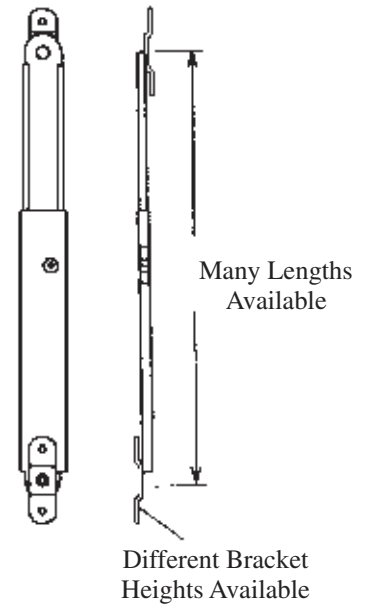

Available Bracket Heights

- .110 (2.8mm)
- .180 (4.6mm)
- .235 (6.0mm)
- .422 (10.7mm)

Four Bar Hinges Projection Window: Friction Adjusters, Limit Devices

#014-18
Friction Adjusters
Standard Duty

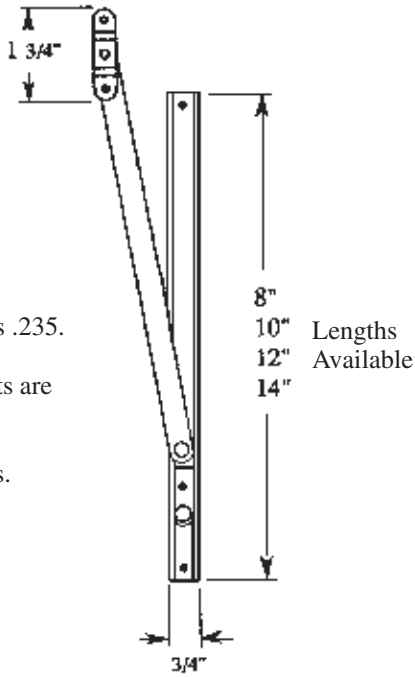

* Bracket height is .235.

Optional brackets are not available for standard duty friction adjusters.

#014-19
Limit Device
with Key Release

#014-19-20
Key Sold Separately

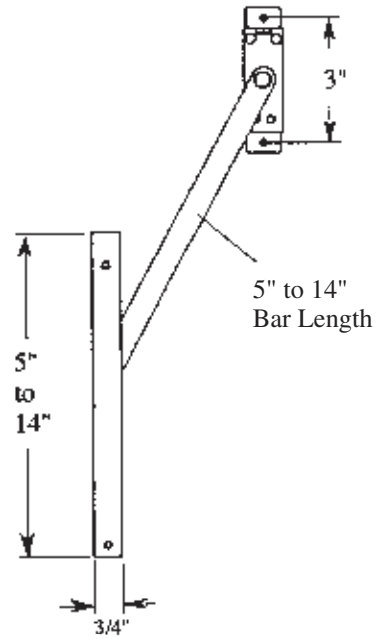

#014-20
Sash Limit Device
For Casement Type Windows

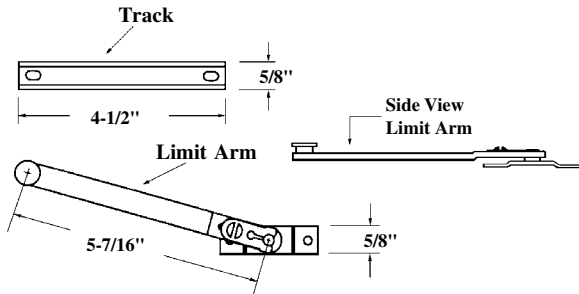

#014-14
Awning & Casement Hinge
Sample Required for Proper I.D.

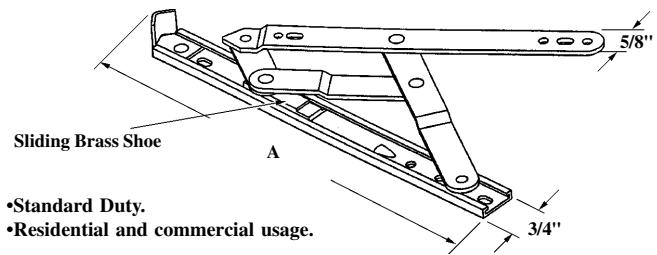
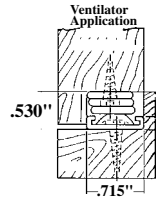

- Standard Duty.
- Residential and commercial usage.

#014-03-XX
Awning Hinge

A	B	C
10"	6-3/4"	6"
14"	6-3/4"	8"
18"	8-3/4"	10"
22"	10-3/4"	12"
26"	12-3/4"	14"

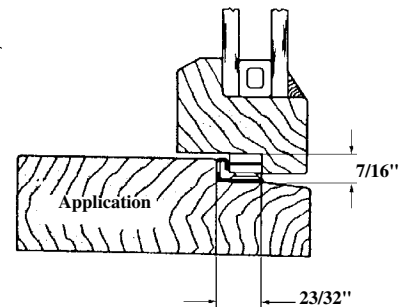
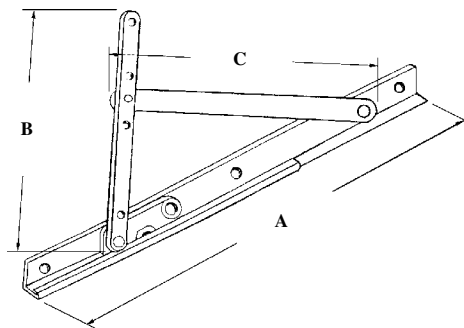

Four Bar Hinges Projection Window: Friction Adjusters, Limit Devices

#014-18 4-Bar Hinge

•Heavy Duty.

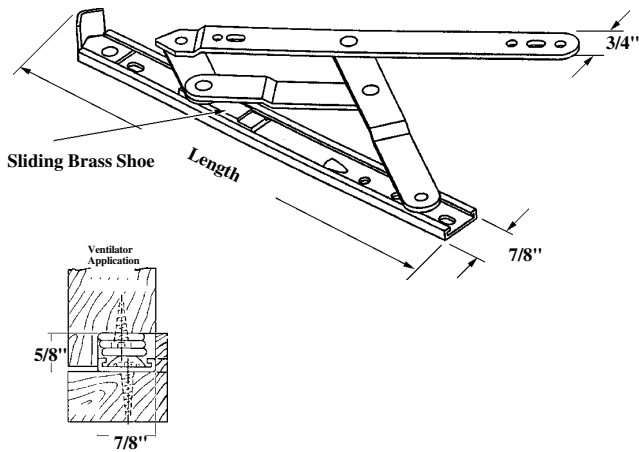

#014-14 Variable Stop for 4-Bar Hinge

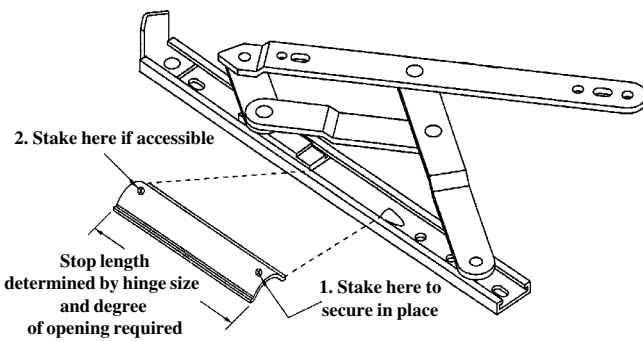

Truth Hinge Part No.			Anderberg Hinge Description
Stainless Steel	Steel	Aluminum	
34.24.00.100	34.33.00.100	34.41.00.100	10" w/Stop (301)
34.25.00.111	34.34.00.106	34.42.00.104	12" w/Stop (301)
34.25.00.111	34.34.00.106	34.42.00.104	12" w/Stop (301)
34.26.00.100	34.35.00.100	34.43.00.100	14" w/Stop (301)
34.27.00.104	34.36.00.103	34.44.00.102	16" w/Stop (301)
34.27.00.104	34.36.00.103	34.44.00.102	16" w/Stop (301)
34.28.00.100	34.37.00.100	34.45.00.100	18" w/Stop (301)
34.29.00.107	34.38.00.105	34.46.00.103	20" w/Stop (301)
34.31.00.106	34.39.00.100	N/A	24" w/Stop (301)
34.86.00.100	N/A	N/A	28" w/Stop (301)

#022-03 Casement Hinge

- Not for use on awning windows.
- To be used specifically with the Maxim® Dual Arm Operator, in order to achieve egress access in required situations.
- Hinge arms are made of heavy gauge steel to give sash weight carrying capability of up to 69 lb. sash.

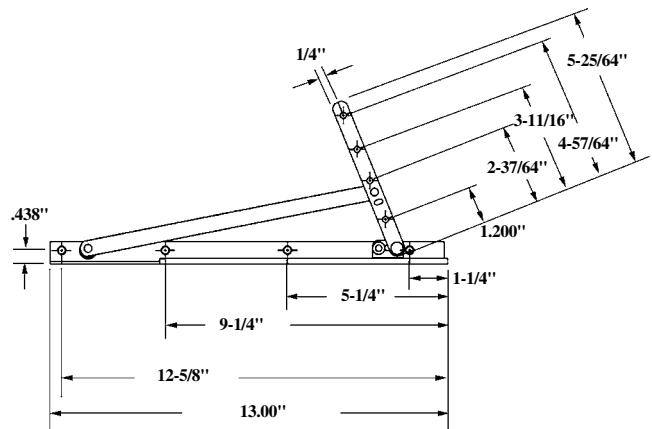
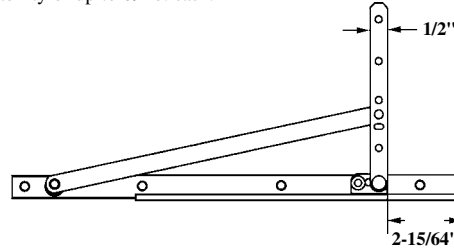

#022-03 Concealed Casement Hinges Sample Required for Proper I.D.

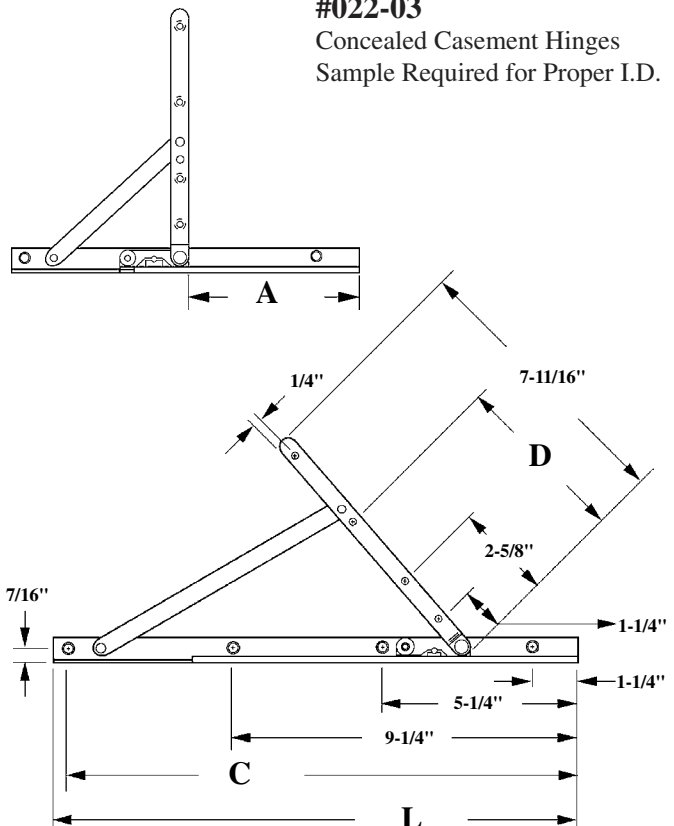

Projection Window: Push Bars, Accessories

*many lengths available

#09-6146 RH Shown
#09-6147 LH
 All Bronze
 (Special Order)

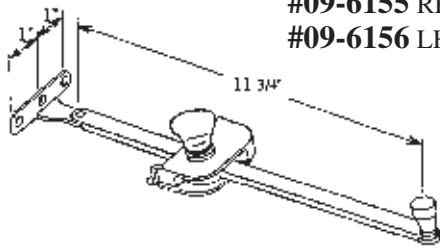

#09-6155 RH Shown
#09-6156 LH

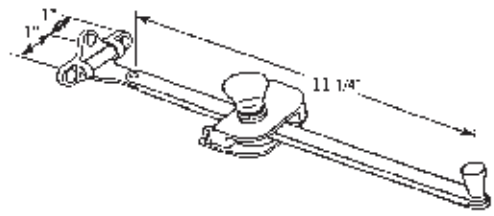

#09-9106

#09-9105

Ends Available for #09-9105

#09-5001

Standard

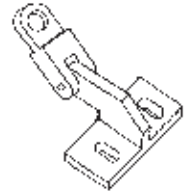
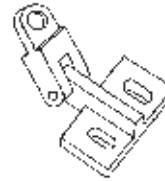
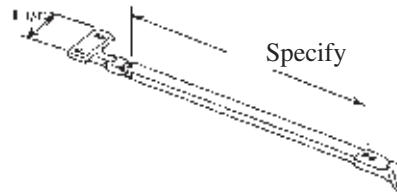
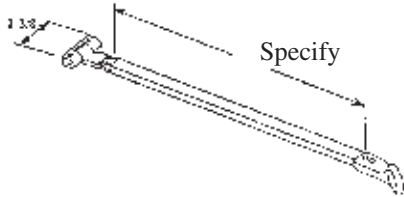

#09-9107

#09-9109

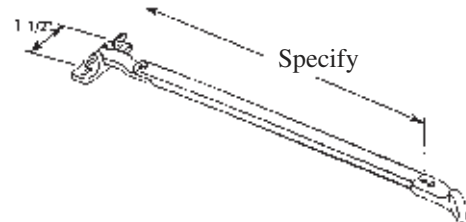
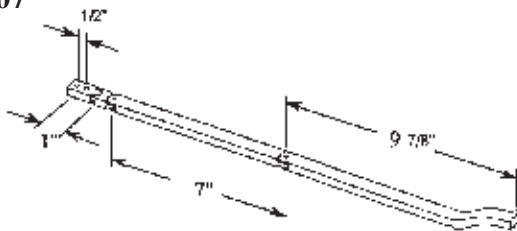

#09-864

Finger Pull

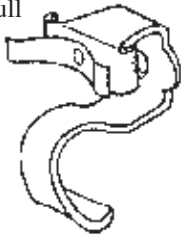

#06-44

Finger Pull



#09-7106

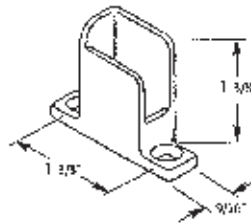

#09-7107

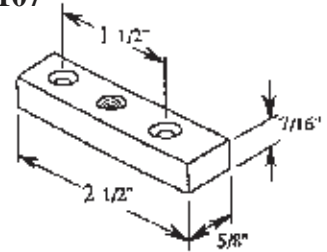

#09-863

Hinge Set

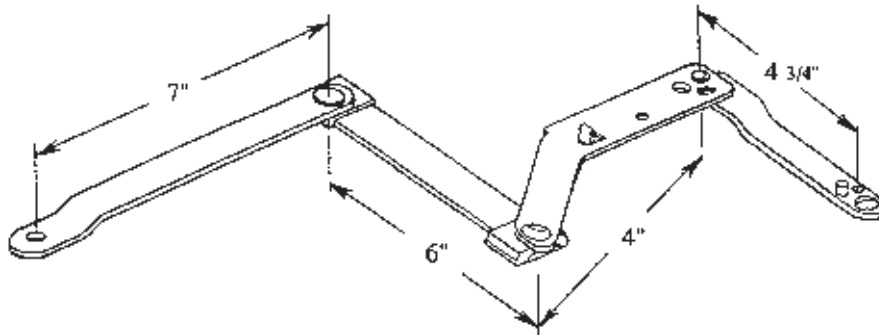

#09-7104 RH Shown

#09-7104 LH

White Bronze

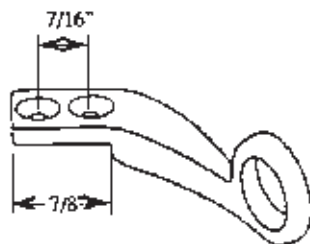

#09-7105

White Bronze

