

Miscellaneous Parts and Accessories

Pole Rings

#04-12
White Bronze

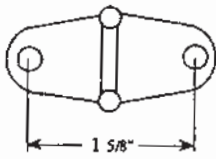

#03-21
White Bronze

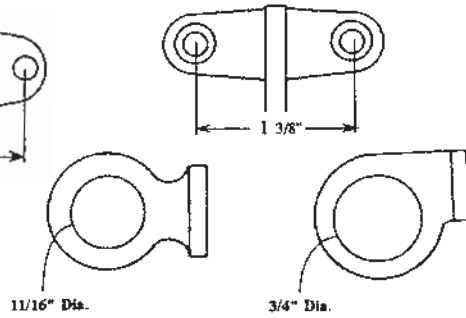

#03-22
White Bronze

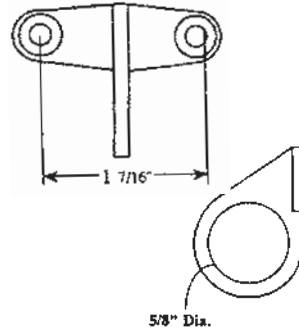

#03-149
Brass Finish

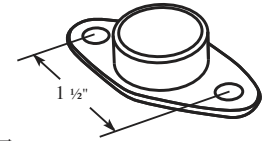

#03-100
Pull Handle
White Bronze

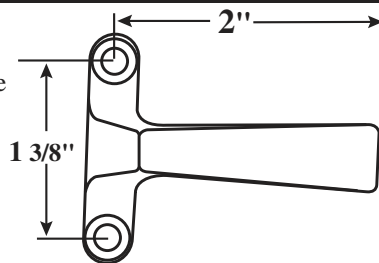

#03-184
Sash Pull
White Bronze

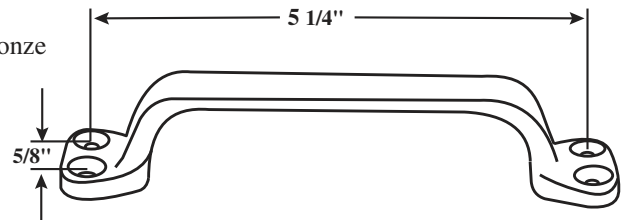

#03-137
Pull Handle
White Bronze

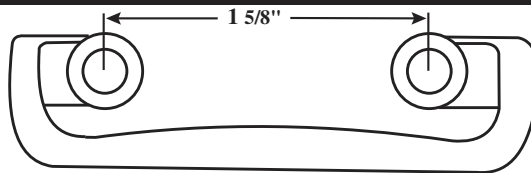

#03-150
Pull Handle
White Bronze

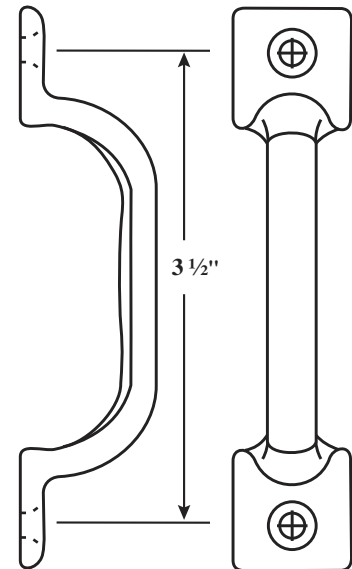

#02-233
Plastic Sash Lift
White

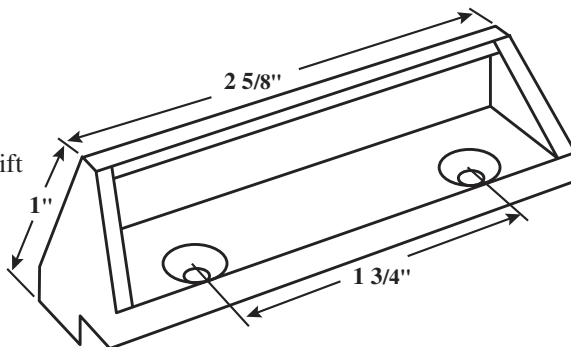

#02-240-XX
Die Cast
Specify Color

Sash Lift

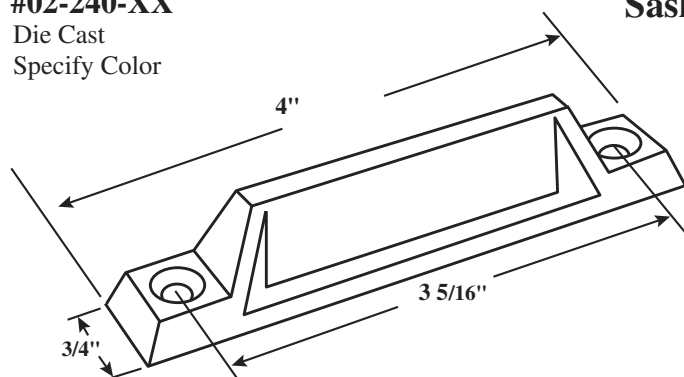

#014-24-XX
Die Cast
Specify Color

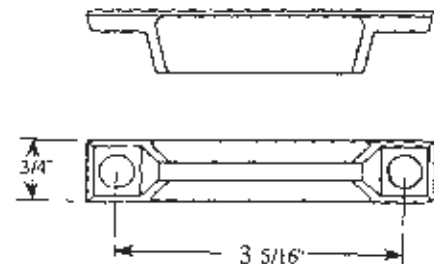

XX = Specify Color

Miscellaneous Parts and Accessories

Handles

#04-11
Solid Brass

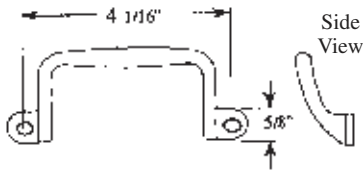

#04-13
Solid Brass

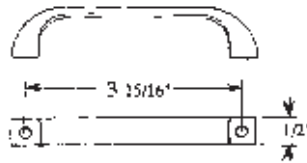

#014-54-XX
Die Cast
Specify Color

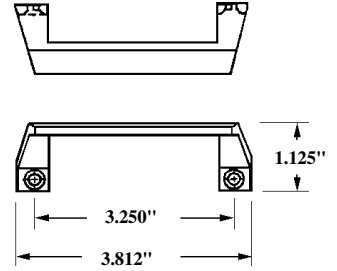

Poles and Pole Hangers

#03-26
Pole Hook Head
White Bronze

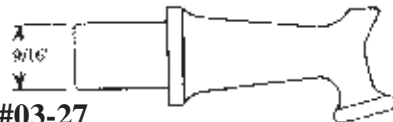

#03-27
Pole Hook Head
White Bronze

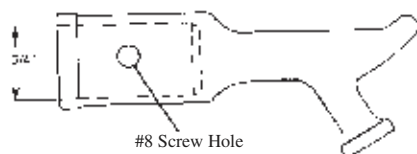

#03-28
Hanger
White Bronze

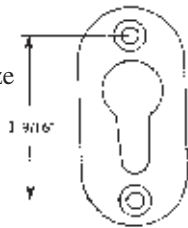

#03-29
Hanger
White Bronze

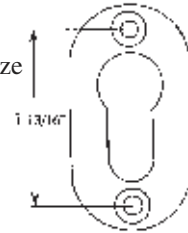

#02-6500

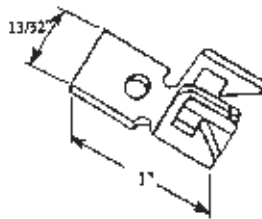

#02-6512

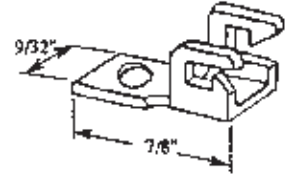

#02-6501

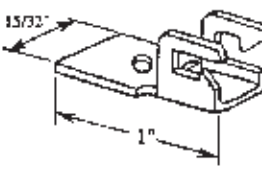

#02-6508

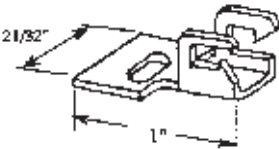

Pole Hook Assembly

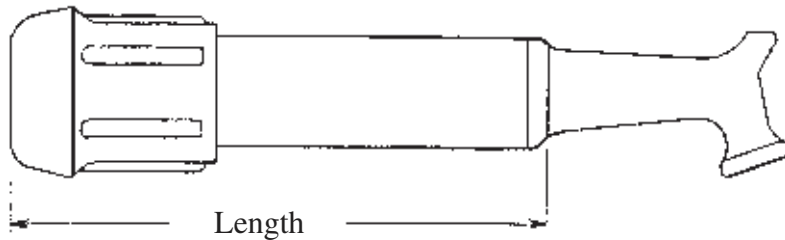

Part Number	Length	Part Number	Length
#03-30	4 Foot	#03-34	8 Foot
#03-31	5 Foot	#03-35	10 Foot
#03-32	6 Foot	#03-36	12 Foot
#03-33	7 Foot		

#017-102

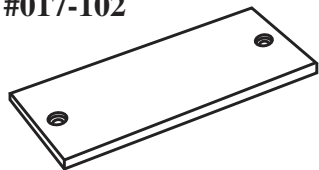

#017-103

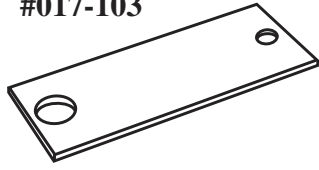

#017-134B

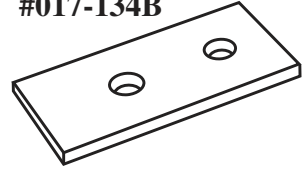

#017-141

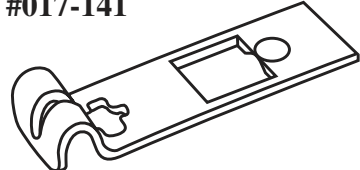

#02-6513

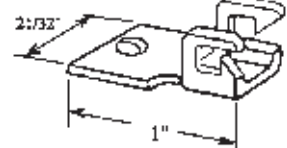

#02-6502

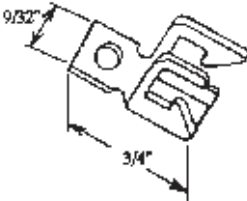

#02-6509

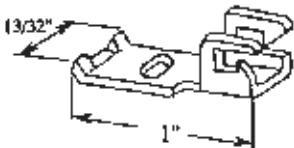

#02-6514

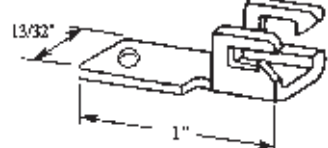

Miscellaneous Parts and Accessories

#02-6503

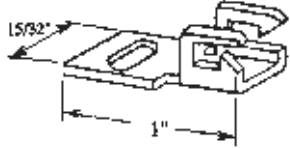

#02-6510

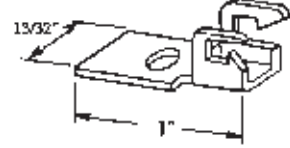

#02-6515

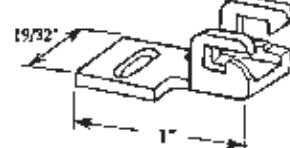

#02-6504

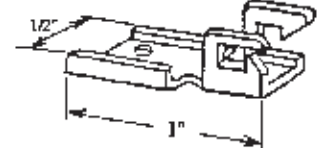

#02-6511

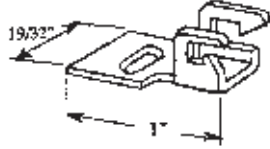

#02-6516

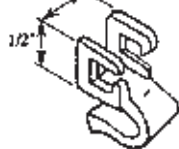

#02-5236

Riveted to Balance

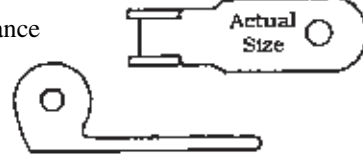

#01-10

Plain Brackets



#01-11

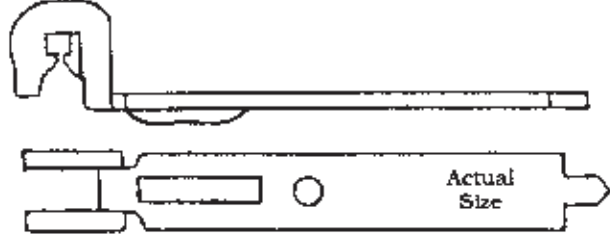

#01-12

Pre-Attached to Balance



#02-523

Riveted to Balance

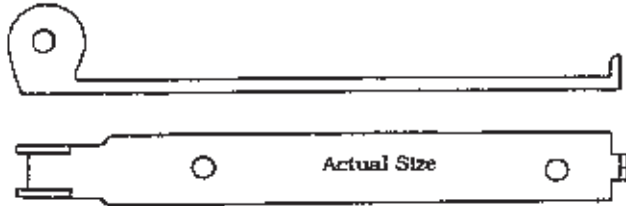

#01-13

Nylon Clad Brackets

#01-16

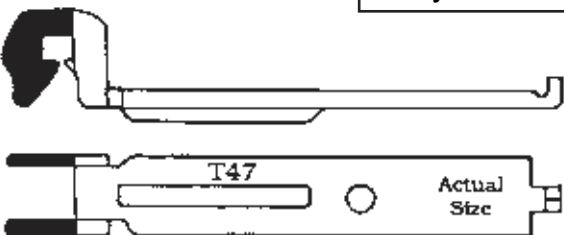

#01-15

Pre-Attached to Balance

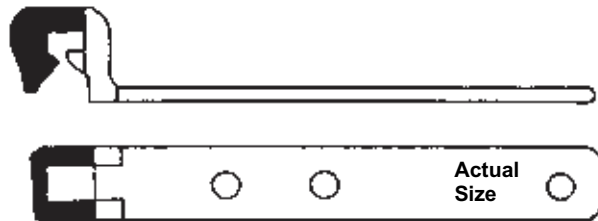

#01-14

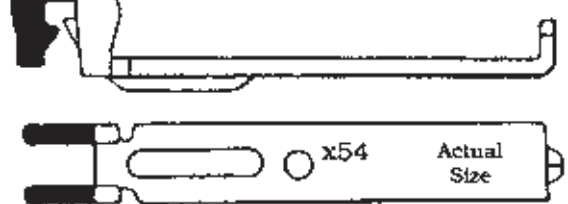

#01-17

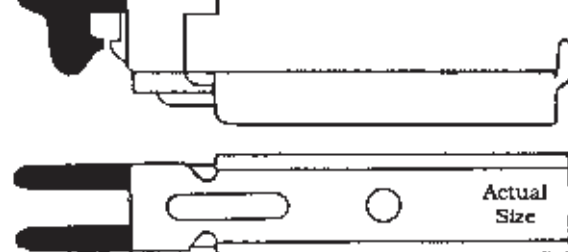

Miscellaneous Parts and Accessories

#01-44
Take Out Clip -
Universal Fit

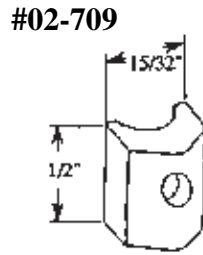
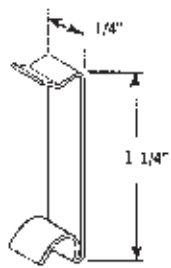

#010-12
3 Piece Assembly

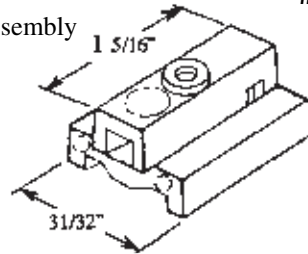

#02-705

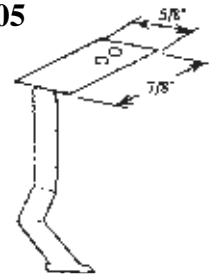

#02-613

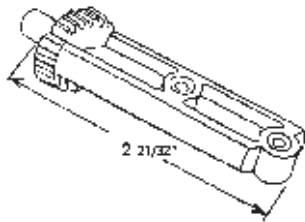

#02-632

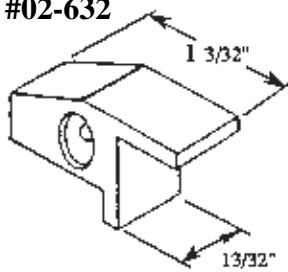

#02-519
Black

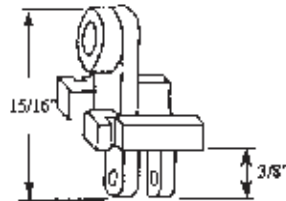

#02-604
Aluminum

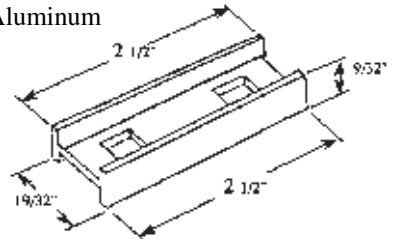

#02-517
Balance Cap

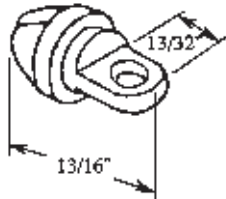

#02-528

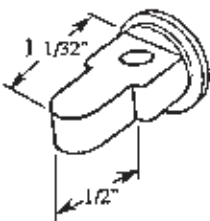

#02-630

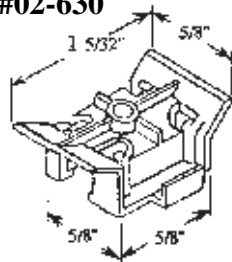

#02-626
Sash Guide-Use with #01-12 Bracket

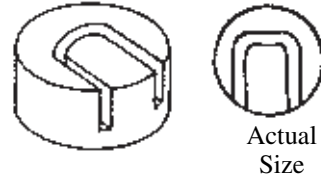

#02-611

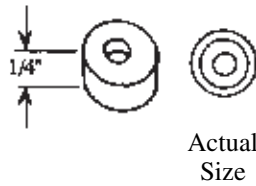

#02-506

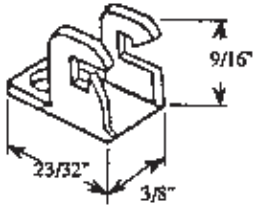

#02-505

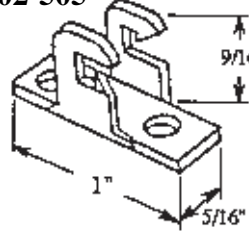

#02-521

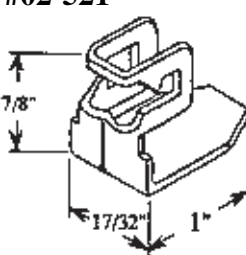

#02-527

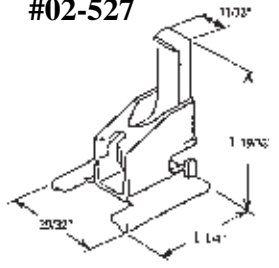

#02-0704

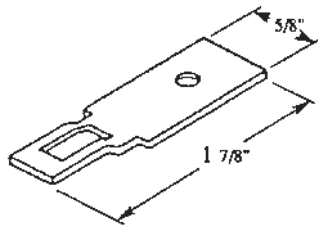

#02-0802

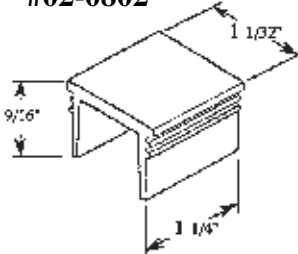

#02-0625 RH
#02-0626 LH

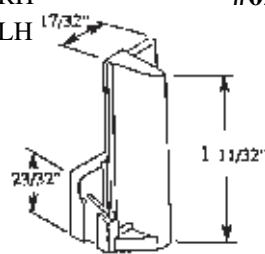

#02-0515

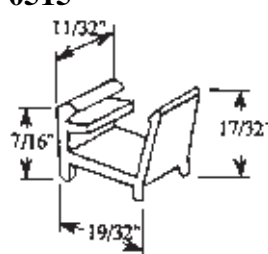

#02-0801

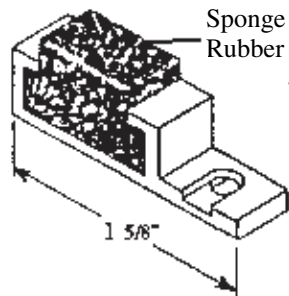

#02-0706

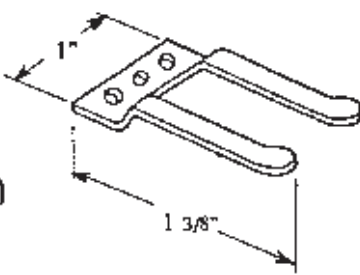

#02-0803
Take-Out
Clip Tool

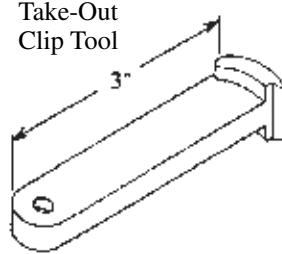

#02-6506

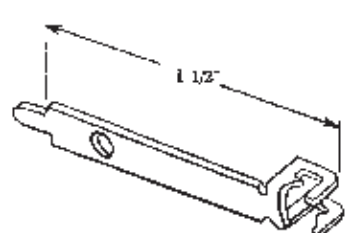

Miscellaneous Parts and Accessories

#02-6507

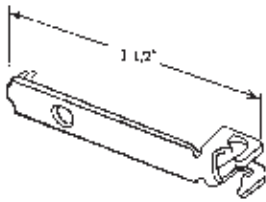

#02-6517

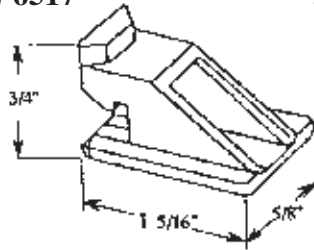

#02-6505

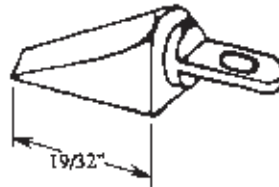

#01-62

Non-countersunk

#01-63

Countersunk

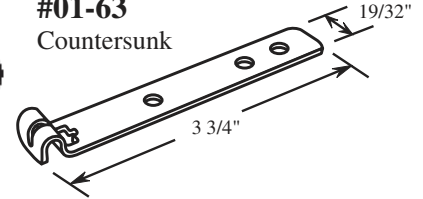

#02-11376

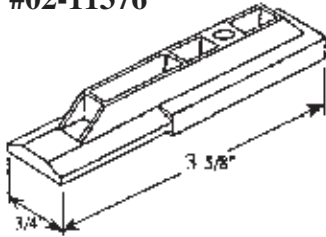

#02-2628

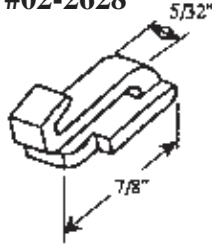

#02-11377

Actual Size

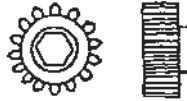

#02-2629

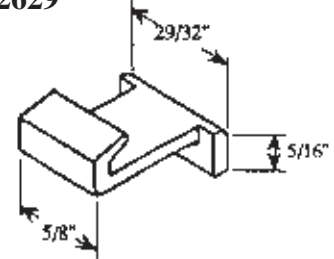

#02-2500

(Use with #05-11 End)

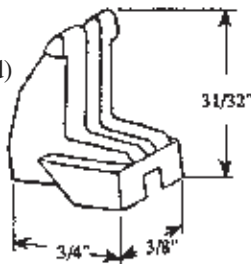

#02-2518

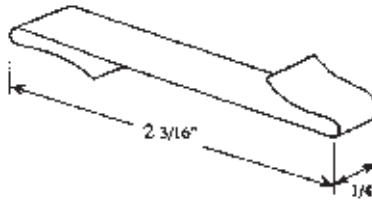

#02-2517

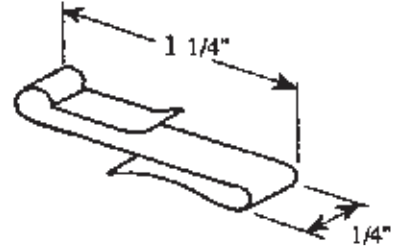

#05-42

(Used with 05-21 Shoe)

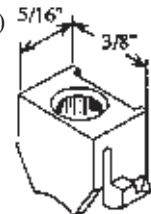

#05-43

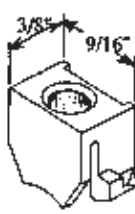

#02-2630

Bushing

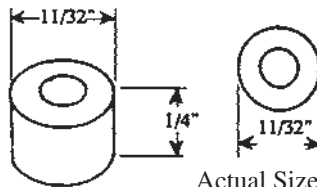

Actual Size

#020-61

Dust Cap

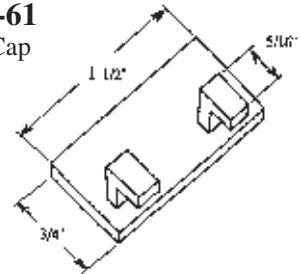

#02-5604 White
#02-5605 Black
Top Sash
Dust Caps

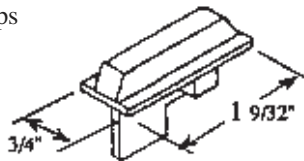

#02-5602 White
#02-5603 Black
Bottom Sash

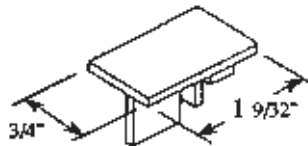

#02-1763

Specify:
Black / White

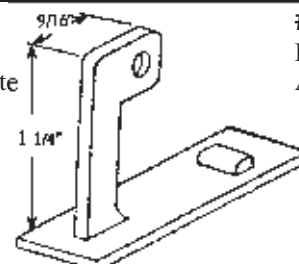

#02-103

Balance Screw
Actual Size



#02-6783

RH/LH Pairs Only

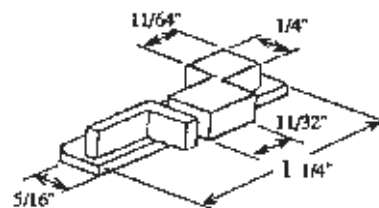

#02-6505

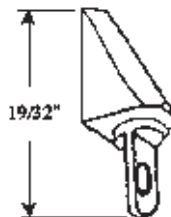

#02-101

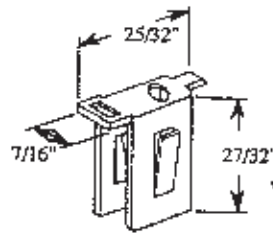

#02-102

Actual Size

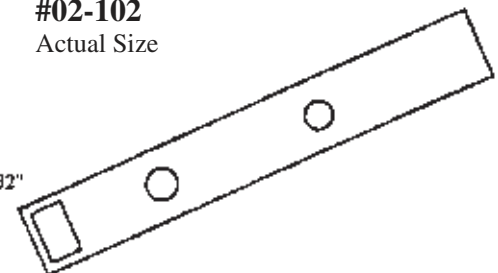

Miscellaneous Parts and Accessories

#01-49
Tool

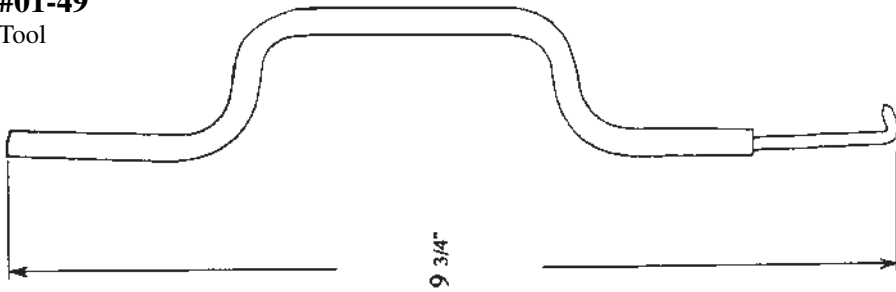

#025-28
Balance Installation Tool

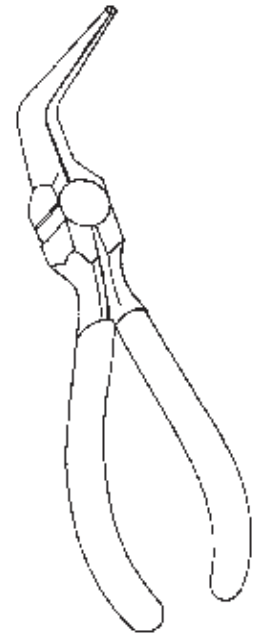

Balance Tensioning - Tools

#01-31

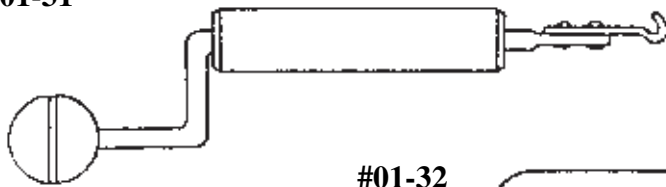

#01-32



#02-509

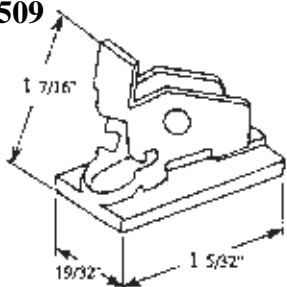

#02-514
Right
#02-515
Left
(Pairs Only)

Metal with
Plastic Base

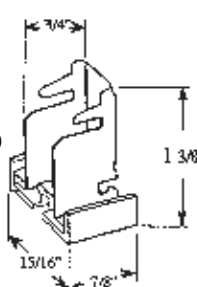

#02-508

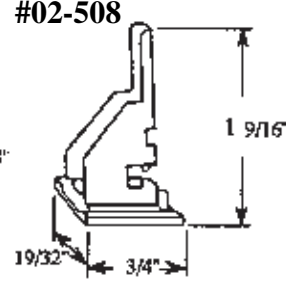

#02-522

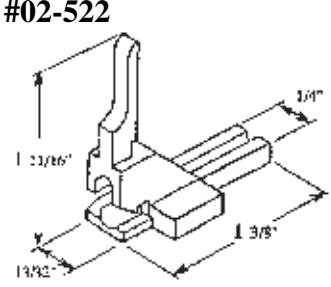

#02-510

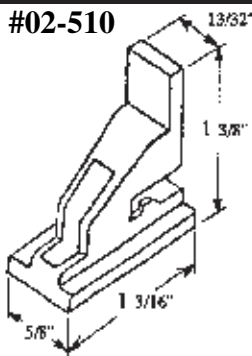

#02-513

Use with
#02-600 Clip

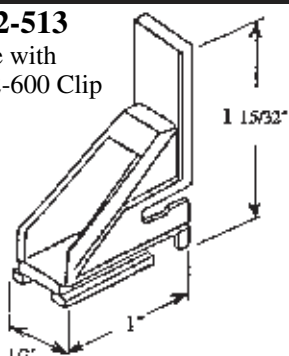

#02-511 Right

#02-512 Left
Use with
#02-602

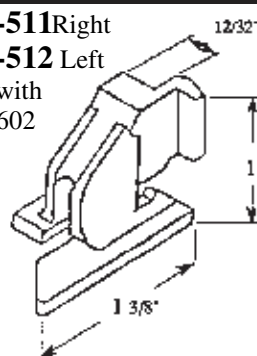

#02-507

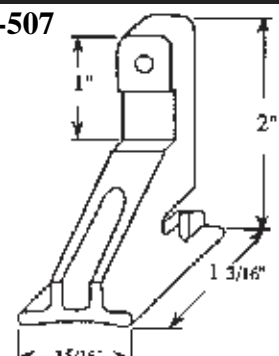

#02-2503

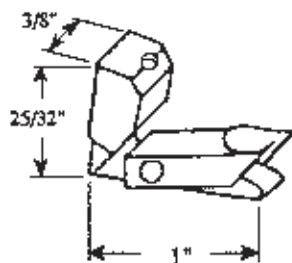

#02-2501

(Use with #05-11 End)

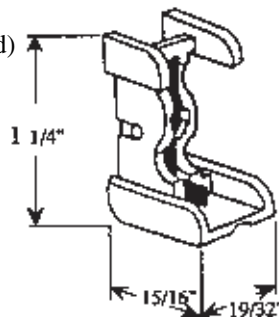

#02-2502 White

#02-2511 Black

