

Instructions for Ordering Window Balances

Tube Balances (Spiral Type)

Please Specify:

1. Balance Series Number
2. Tube Length
3. Coupling Color
4. Rod Extension (If Needed)
5. Metal or Plastic Tube -
(If Metal, is it a Solid Tube or a Tube with a Seam)

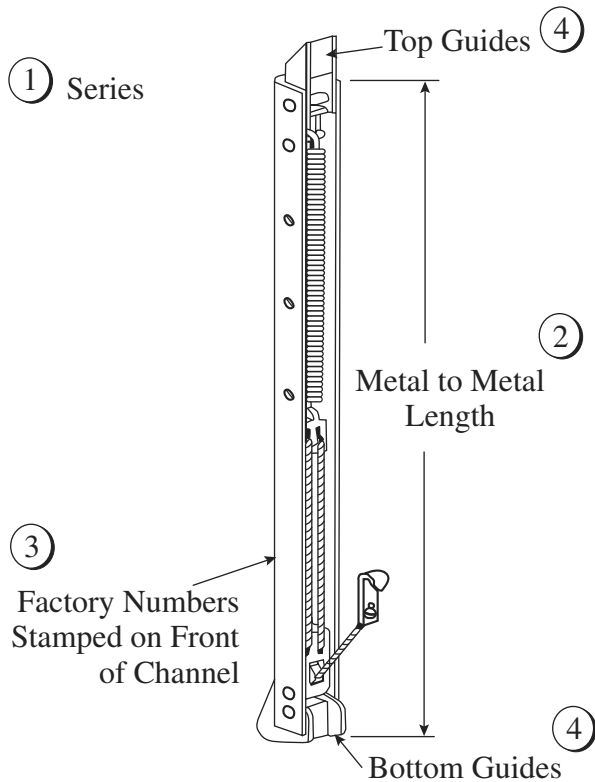
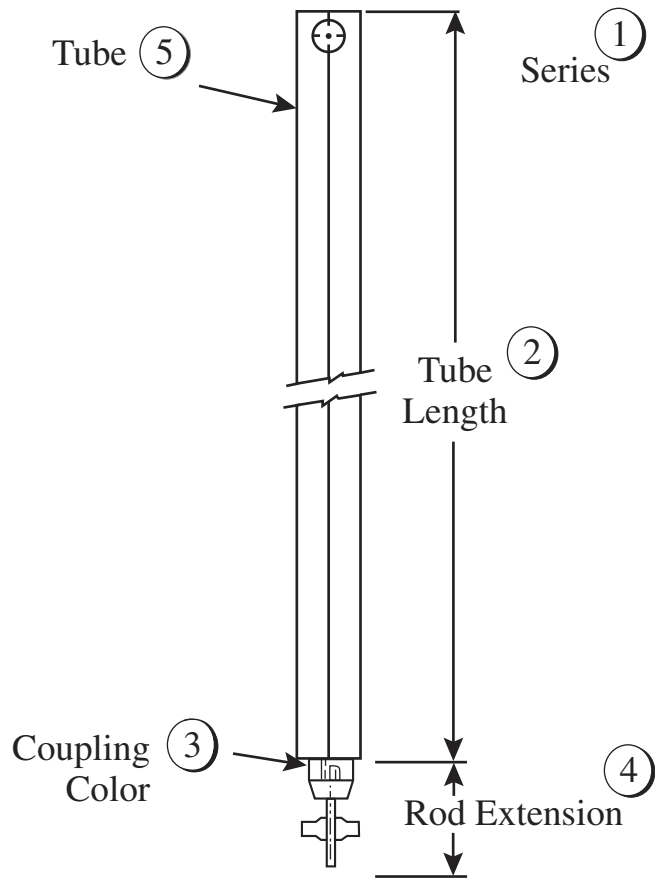

Channel Balance (Block & Tackle)

Please Specify:

1. Balance Series Number
2. Metal to Metal Length
3. Factory Numbers
4. Top and Bottom Guides
(See Accessories Pages)

Block and Tackle Balances

Series 300

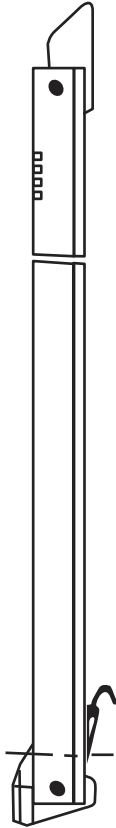

Series 350

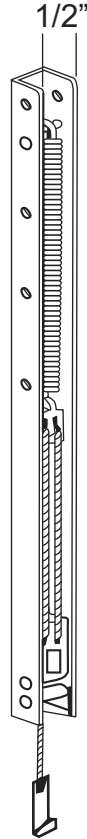

Series 400

Channel Width
9/16"

Channel Depth
5/8"

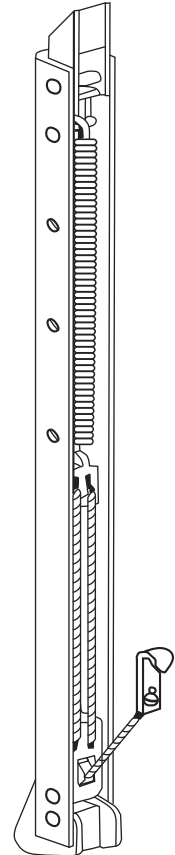

Series 430

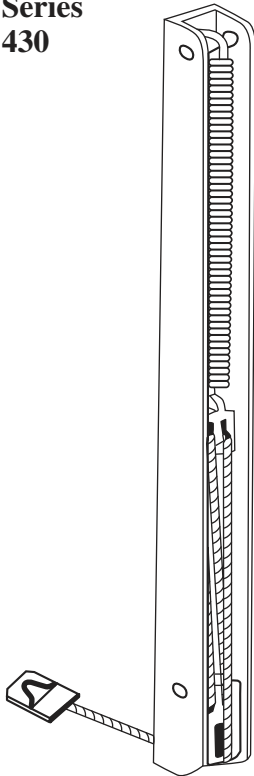

Series 475

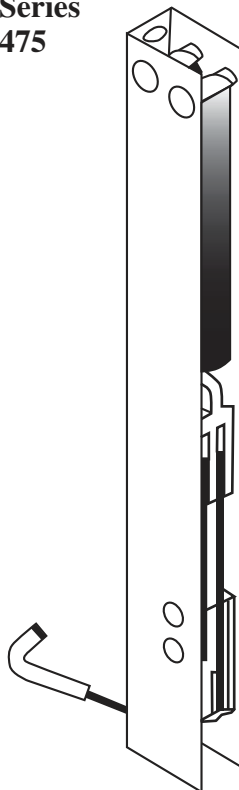

Overhead Balances

Series 460

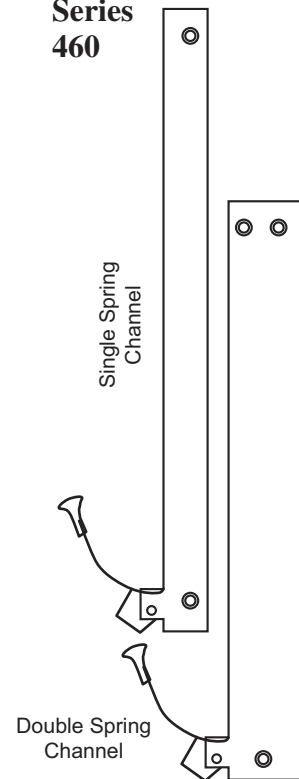

Devac Balances

Block and Tackle Balances

Series 450

Note: Must specify end attached to spring.

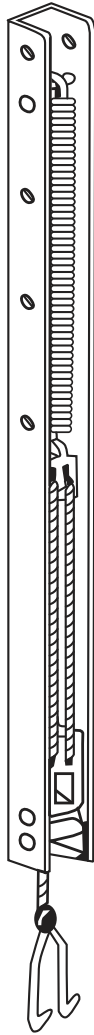

Series 550

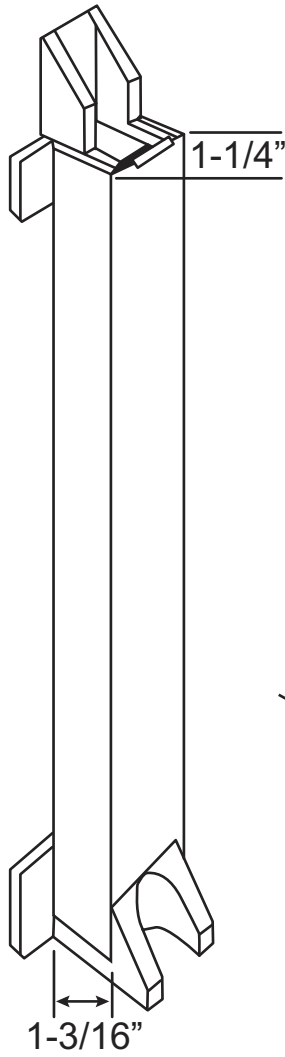

Series 800

Channel Width
13/32"

Channel Depth
3/8"

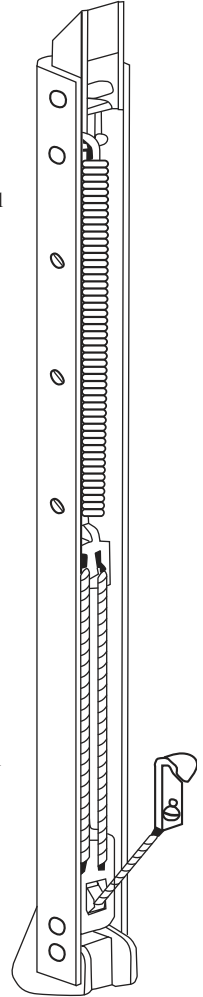

Series 500

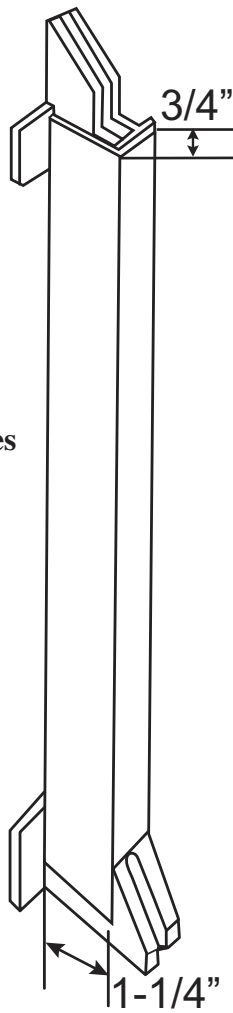

Series 700

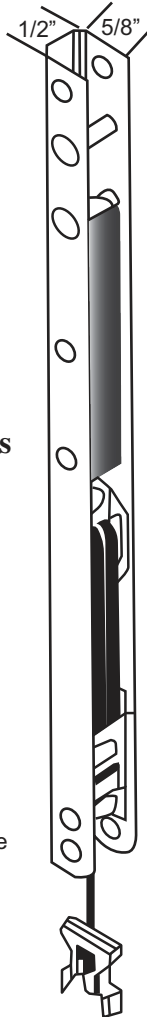

End view of channel shape of ribbed balances

Spiral Balances

Series 40

Note Coupling Color

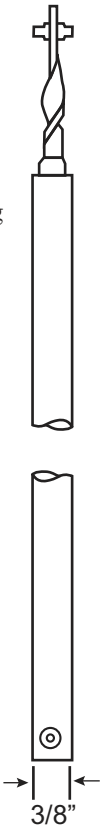

Series 50

Note Coupling Color

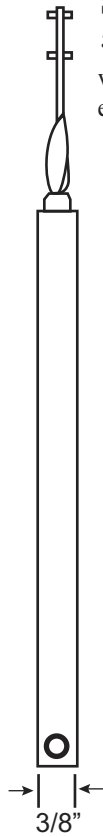

Series 50
w/ rod extension

Note Coupling Color

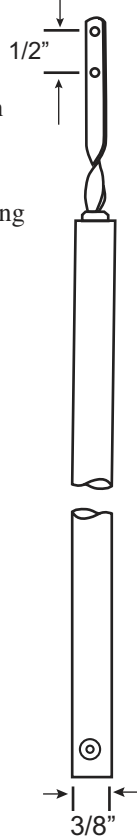

Series 60
Grey 5/8" tube

Series 60A
Black 3/8" tube

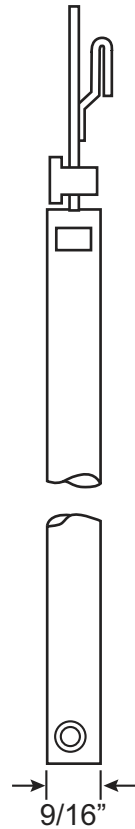

Non Tilt 5/8" Series 100

up to 30 lbs.

Note Coupling Color

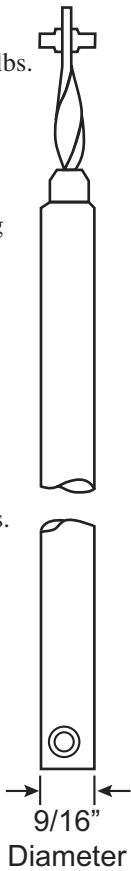

Series 100

w/ rod extension

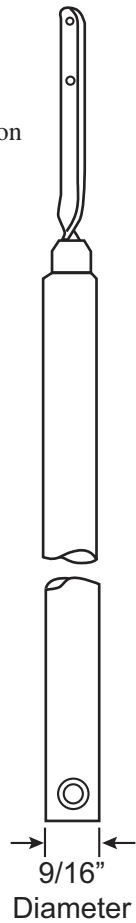

Series 200

up to 30 lbs.

Note Coupling Color

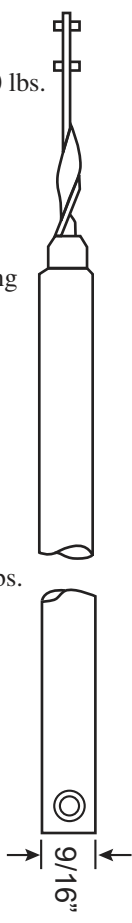

Series 250

30-40 lbs.

Series 600

Ultralift "Turbo"

*Must be ordered for specific weight.

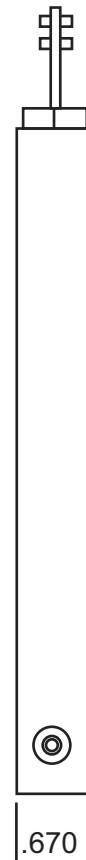

Turbo II™



New "TURBO II"™ Window Balances

Turbo Balance Brackets

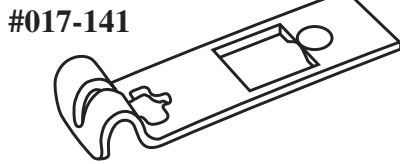
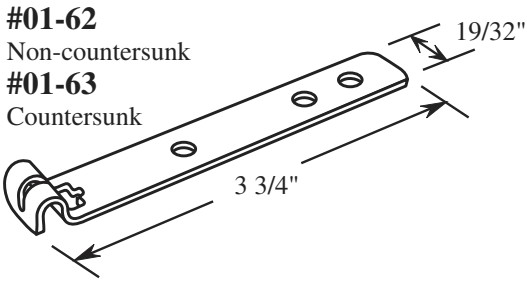

**Please Call
for
Details!**

Features

High Output Balance

70% Lift Assistance

For Heavy Sash Weights Up to 160 Pounds

Eliminates Load Bearing Plastic Parts

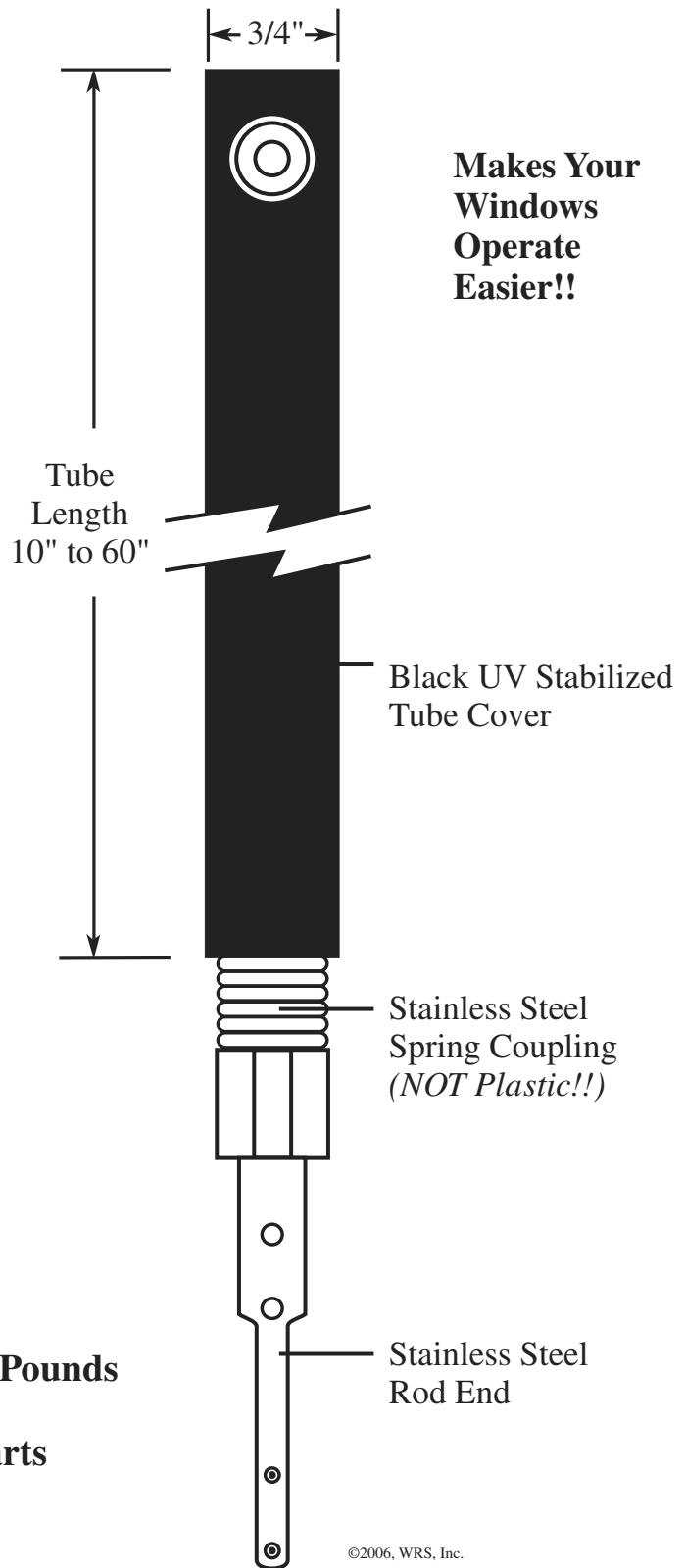

**Makes Your
Windows
Operate
Easier!!**

©2006, WRS, Inc.

Tape Balances Contact Force Balances

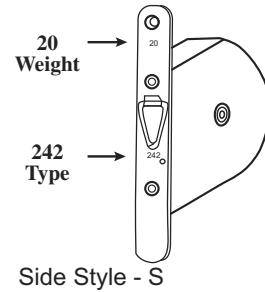
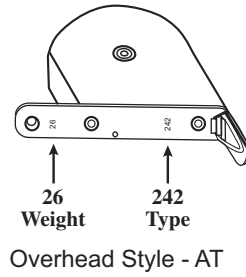
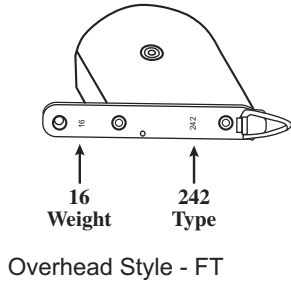

Tape Balance Technical Information

Size	A	B	C	D	E	G
242AT	3	4-5/16	7/8	1-5/16	5/16	3
150AT	3-3/8	4-11/16	1-1/8	1-5/16	3/8	3-3/8
154AT	3-3/16	5-5/32	1-1/4	1-17/32	15/32	3-15/16
242S	3	5-5/8	7/8	1-5/16	5/16	3
150S	3-3/8	6	1-1/8	1-5/16	3/8	3-3/8
154S	3-15/16	7	1-1/4	1-13/32	15/32	3-15/16
242FT	3	4-11/16	7/8	1-5/16	3/8	3
150FT	3-3/8	5-1/8	1	1-5/16	3/8	3-3/8
154FT	3-15/16	5-13/16	1-1/4	1-17/32	11/32	3-15/16

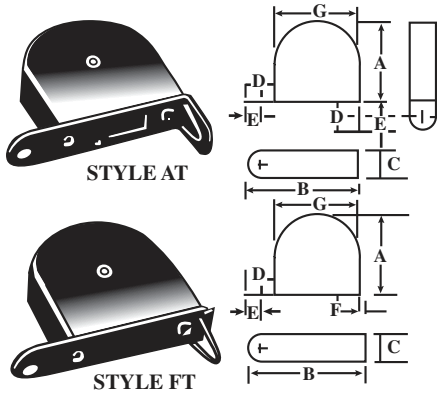

*#01-801-xx #01-802-xx #01-803-xx

WGT. OF SASH	4-26 LBS.	4-35 LBS.	20-50 LBS.
Balance Size	242	150	154
Standard Tape Lgth.	39"	50"	50"

*xx denotes mounting style (AT,S,FT)

#012-xxx*

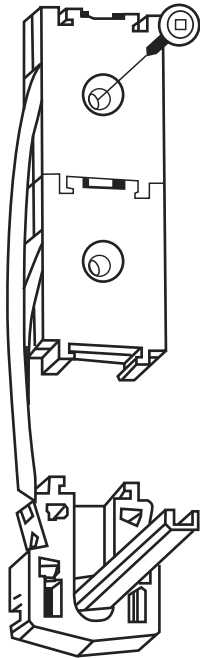

#01-152-xxx*

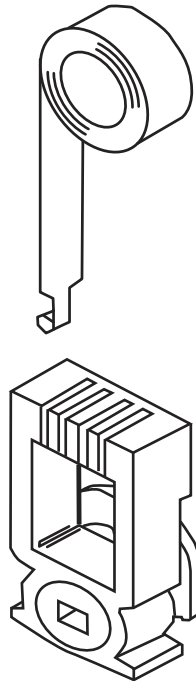

#01-900-xx*

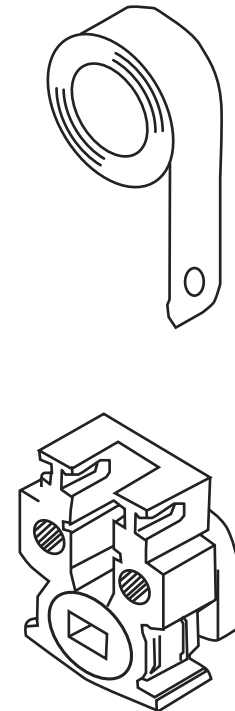

*all balances are custom ordered for weight and size of sash